

LOCKSMITHING TOOLS

Clip Removal Tool

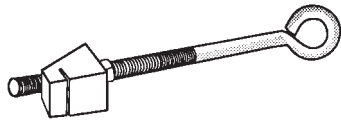

Special feature — spring loaded ball bearing holds automotive cylinder clip in tool until YOU want it removed. Design allows the Jaws II-L to bump up against the lock to help remove clips that are hard to take off.

Part No.: KDX K 2

G.M. Decoder

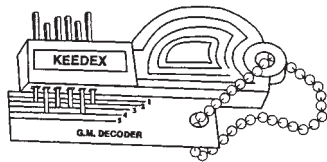

Decodes all tumblers in one step without complete disassembly of the lock. Pick side-bar down. Press the K-4 firmly into the 6 chambers of the lock. Read cuts with gauge provided.

- Made of Lexan
- Guaranteed for life
- Stainless steel fingers
- Durable aluminum card
- Instructions and case included

Part No.: KDX K 4

Master Follower



This remarkable follower is a wise choice for either the newcomer or master locksmith. Made of SOLID BRASS, it will outlast those made of plastic or aluminum. The capabilities of this machined follower far exceed any follower on the market today. It can be used as a regular follower or master pin remover and follower on Schlage, Sargent, Kwikset, Weiser, Almont Padlocks and many others. Special taper allows smooth operation and better control over sticking pins.

Part No.: KDX K 6

Impressioning Plate

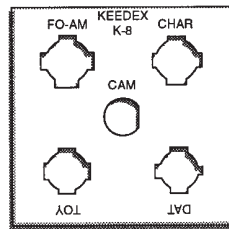

Specialized plate which holds locks as if they were still in the vehicle. The Impressioning Plate works with your vise to hold Chrysler, Ford, American Motors, Toyota, Datsun and all standard cam locks. Made of stainless steel, it will hold all of the above locks firmly without crushing the outside casing. A must for every shop.

Part No.: KDX K 8

Protect-A-Lok

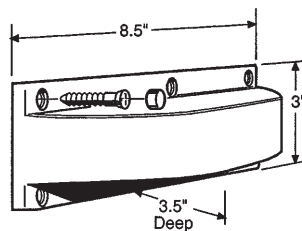
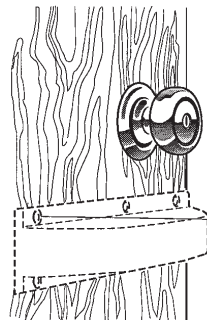

Finally a product designed to protect locks and other hardware from impact damage, The Keedex K-12 Protect-A-Lok, made from Lexan polycarbonate, is virtually indestructible. Designed for use in areas where locks may have a chance of getting hit by carts, forklifts, or moving vehicles. Can be used with levers, knobs, or panic hardware with any size backset. Installs in minutes. Guaranteed for five years.

Part No. **Finish**
 KDX K 12 ----- Cream
 KDX K 12D ----- Duranodic

Style Guard

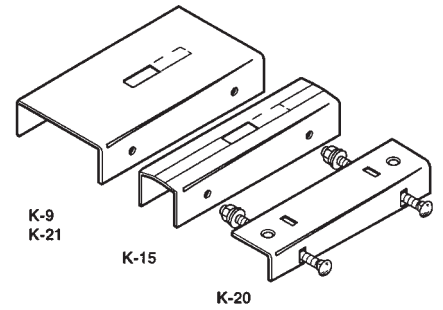

Made of 12 gauge steel, Style Guard reinforces or repairs aluminum stile doors. K-9 for standard 4" jamb and K-21 for 4 1/2" jamb. Designed with a "knock out" for either the W&F or the Adams Rite bolt. Powder coat finish.

A=Aluminum, B=Duranodic.

Part No.
 KDX K 9A
 KDX K 9B
 KDX K 21A
 KDX K 21 B

Double Door Style Guard

Finally a better way to secure a set of double aluminum doors! 12 gauge steel increases security and can repair doors that have already been attacked. Designed with knock out feature to make a W&F into an Adams Rite.

A=Aluminum, B=Duranodic.

Part No.
 KDX K 15A
 KDX K 15B

Offset Style Guard

To complete our Style Guard line we finally have a guard for the offset aluminum door or doors that swing one way with jamb stops. This non-handed guard is easy to install and comes with pop rivets and carriage bolts.

A=Aluminum, B=Duranodic.

Part No.
 KDX K 20A
 KDX K 20B

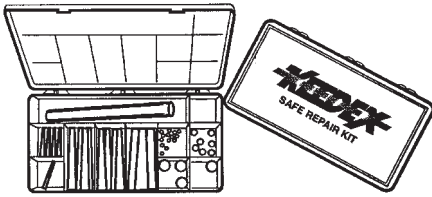
LOCKSMITHING TOOLS
Safe Repair Kit

Developed specifically for locksmiths and safemen, these steel taper pins and corresponding ball bearings will prove invaluable when repairing safes that have been drilled open. Five sizes of taper pins milled from bar steel to help you repair drill holes from 1/8" to 1/2". Four sizes of corresponding ball bearings to complete a professional repair. Reorder numbers included.

Part No.: KDX K 16

Safe Drill Bits

Carbide Tip

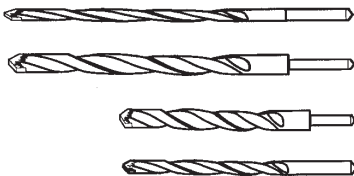

- High Quality
- Specially sharpened on a diamond wheel
- Made in the U.S.A.
- Ideal for penetrating hard plate and other demanding metal work

Part No.	Size
KDX K 14X4	1/4 x 4"
KDX K 14X6	1/4 x 6"
KDX K 38X4	3/8 x 4"
KDX K 38X6	3/8 x 6"

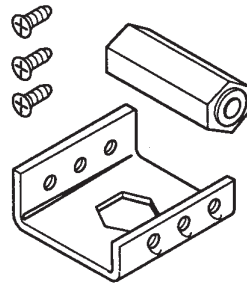
Security Guide & Bolt

Customers with double aluminum glass doors on their business require more than security — the Keedex K-17 Security Guide & Bolt helps provide the answer. With a relatively simple installation, you eliminate the possibility of a burglar breaking in by merely breaking the plastic guides and pins provided by the doors manufacturer.

Made of steel, cadmium plated to prevent rust, the Security Guide replaces the plastic guides of Builders Brass Works and Slide-Co. The installation of our K-15 Double DoorStyle Guard is recommended for even more security in commercial or industrial application.

Part No.: KDX K 17

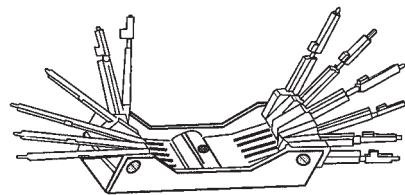
Change Key Set

How many times have you searched and searched for a particular change key at the bottom of your tool box? Keedex came up with a solution. The K-18 Change Key Set is a set of the twelve most common change keys, all in a handy case. Keys fold out "knife style" to select the proper tool. Case is engraved with description of uses. Keys are made of stainless steel.

Contains the Following Keys:

- #1 Mosler-35-4 Wheel
- #2 Mosler-302-3 Wheel
- #3 S&G-AMSEC-3 Wheel
- #4 S&G-6720-3 Wheel
- #5 Diebold-180-3 Wheel

- #6 Diebold-177-4 Wheel
- #7 S&G Padlock-3-Wheel
- #8 S&G-4163
- #9 LaGard-1R-3 Wheel
- #10 LaGard-3-Wheel
- #11 LaGard-4-Wheel
- #12 LaGard-AMSEC-3 Wheel

Part No.: KDX K 18

Profile Cylinder Follower

A simple but effective solution to the frustration of servicing profile cylinders. Special magnetic design for easy operation.

Part No.: KDX K 19

Lever Opening Tool

If you can slide this tool under the door, you can open it!

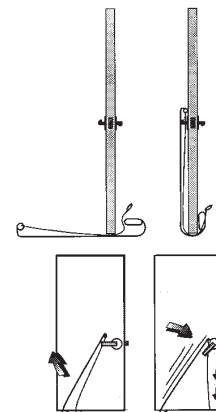

This amazing tool is invaluable for lockouts involving lever locks. Especially important for situations involving locks that have malfunctioned and that are pick resistant. Save precious time and valuable hardware.

Part No.: KDX K 22

LOCKSMITHING TOOLS

Roll Pin Kit

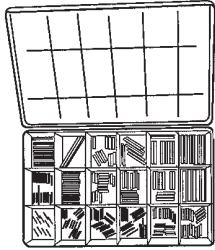

An assortment of the zinc plated roll pins most commonly used by locksmiths. Includes sizes 1/16" through 5/32" in diameter and 3/8" through

1 1/2" in length. 18 different sizes. 480 pins total. Packed in a durable, 18 compartment plastic box. Also available in metric (F/O); specify KDX K-RP-M.

Part No.: KDX K RP

Armored Door Loops

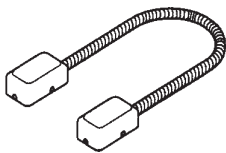

Use these door loops when you need to transfer electrical current from the door frame to the door.

- Available with either and 18" or 24" Flexible Armored Conduit
- Entire assembly has an attractive and durable powder coat finish
- Pre-drilled hole in base

Part No.	Size	Finish
KDX K DLA	18"	Aluminum
KDX K DLB	18"	Duranodic
KDX K DLA24	24"	Aluminum
KDX K DLB24	24"	Duranodic



All stainless steel design with stainless mounting screws.

Part No.	Size	Finish
KDX K DS	18"	Stainless Steel

Cylinder Guard Ring

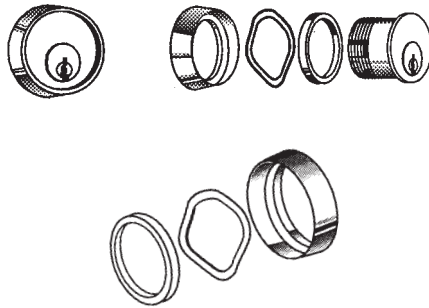

K 24

- Hardened-steel
- Free spinning
- Tapered cone-shape
- Accommodates up to 1 1/8" cylinders
- 6 to a pack for savings and convenience
- Each pack contains 6 hardened steel rings, 6 stainless steel wave washers and 6 spacing collars

Part No.	Finish
KDX K 24A	Aluminum
KDX K 24B	Duranodic

Cylinder Guard Ring

Extra Large

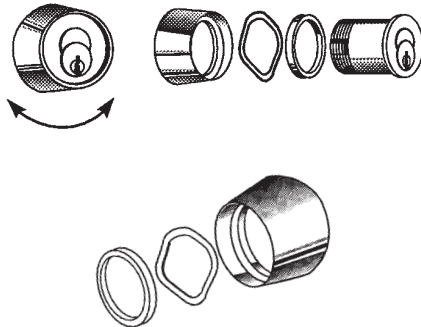

K 24L

Specially designed to be large enough to accommodate 1 1/4"-1 3/8" high security & interchangeable core cylinders. Each pack contains 1 hardened steel ring, 1 stainless steel wave washer & 1 spacing collar.

Part No.	Finish
KDX K 24LA	Aluminum
KDX K 24LB	Duranodic

Spin Out Screwdriver

For Mortise Cylinders

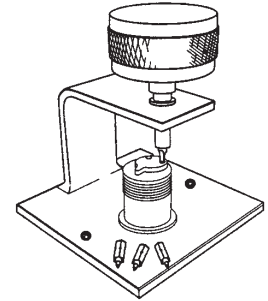

How many times have you struggled, trying to remove the cam screws on mortise cylinders? The "Spin Out" is specially designed to remove even the most stubborn screws. The "Spin Out" features a screwdriver with an oversized handle for extra torque. Four sizes of interchangeable screwdriver bits — two slotted and two Phillips. Includes stand, with bronze bearing, to prevent the screwdriver from slipping. Allows you to provide constant, even pressure to the screws.

- Prevents injuries to the hands caused by a screwdriver slipping
- Prevents stripped-out screw heads
- Allows for the removal of even the most stubborn screws

Part No.: KDX SPIN

Tamper Resistant Screwdriver



Invaluable For:

- Automotive Work
- Access Control
- Commercial/Institutional Locksmithing

This screwdriver comes with eleven interchangeable tips.

- Six tamper resistant torx tips (T10, T15, T20, T25, T27 & T30)
- 3 tamper resistant hex tips: 5/32", 3/16", 7/32"
- Two spanner tips (#6 & #8)
- All tips fit into the screwdriver's storage handle

Part No.: KDX TAMPER

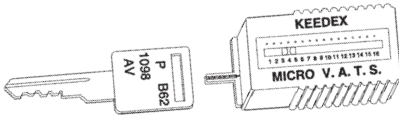
LOCKSMITHING TOOLS
Micro V.A.T.S Interrogator

The Micro V.A.T.S. lets you interrogate the system without disconnecting any wires. No special adapters are needed. The K-VATS operates in the following fashion:

First cut a functional mechanical key for the ignition. Then insert the key into the ignition. Next slide the Micro V.A.T.S. unit over the head of the key.

Use the selector switch on the Micro V.A.T.S., to determine which of the fifteen values, is the correct one that will start the engine. It is necessary to wait the required amount of reset time (approximately 3 1/2 – 4 minutes) between attempts. The numbers on the Micro V.A.T.S. correspond to the fifteen values of the VATS key blanks.

Charts are included that allow you to use your OHM meter as a key identifier.

Part No.: KDX K VATS

Adapter for double sided VATS:

Part No.: KDX K VATS DBL

Master Follower for Corbin Russwin

The new K-6-COR is designed for Corbin Russwin locks. It is a two piece follower that can be used with both .500" and .550" plugs. Made of solid brass. It can be used as a follower, or as a master pin remover. Special taper allows smooth operation and better control over sticking pins.

Part No.: KDX K 6 COR

WELDABLE GATE BOXES

Precision Engineered 14 Gauge Steel

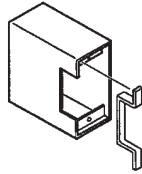
Strike Boxes
Electric Strike Box

This weldable gate box is used for installing the Eff 11BS, Rofu 1106 & the Trine 005 electric strikes. 3 3/4"H x 3 1/2"L x 1 9/16"W.

Part No.: KDX K BXES1

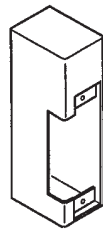
Electric Strike Box

A weldable gate box used for installing the Adams Rite 7100, 7101, 7140 and H.E.S. 5000U (501 Option) electric strikes. 6 7/16"H x 2 3/8"L x 1 3/4"W.

Part No.: KDX K BXES3A

Electric Strike Box (not shown)

For the Trine 001. 6 1/16"H x 2"L x 1 1/2"W.

Part No.: KDX K BXES8

Lock Boxes
Single Lock Box

2 3/8" backset. 2 1/8" hole. 3 1/2"H x 4 1/2"L x 1 1/2"W.

Part No.: KDX K BXSGL

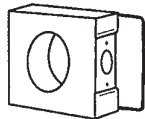
Single Lock Box

2 3/4" backset. 2 1/8" hole. 3 1/2"H x 4 3/4"L x 1 1/2"W.

Part No.: KDX K BXSGL234

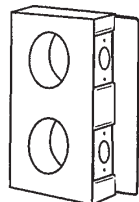
Double Lock Box

2 3/8" back set. 2 1/8" holes. 6 7/8"H x 4 1/2"L x 1 1/2"W.

Part No.: KDX K BXDBL

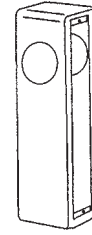
Lock Boxes
Box for Adams Rite

Lock box for the Adams Rite 1850S, 1851S, 4710 & 4711. Fits the Assa 8508, 8513 & 8518. Also used with the International DH1822 & DL4511. 1 1/8" backset. 7"H x 1 15/16"L x 1 3/4"W.

Part No.: KDX K BXAR

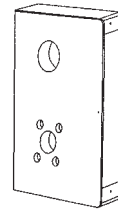

Box for Mortise Locks
Weldable Gate Box — Schlage L Series. Sargent 7700/8100. 8 1/8"H x 4 5/8"L x 1 3/4"W.

Part No.: KDX K BXMOR1

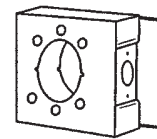
Box for Schlage Rhodes

Use this box with the Schlage Rhodes. 4 1/8"H x 4 3/4"L x 1 3/4"W.

Part No.: KDX K BXRHO

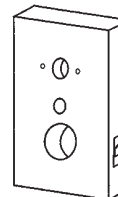
For Unican 1000 Series Alarm Lock T2 and T3

A weldable gate box used for installing the Unican 1000 series and Alarm Lock T2 and T3. 9 1/4"H x 5 1/2"L x 1 3/4"W.

Part No.: KDX K BXSIM