

**RESIDENTIAL HARDWARE**

**Open Window Lock**

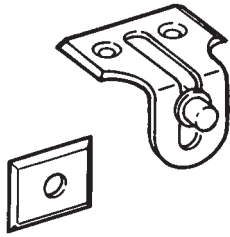

Steel. 1<sup>9</sup>/<sub>16</sub>" × 1<sup>3</sup>/<sub>8</sub>" plate, 1 × 3/4" strike.  
25 per box.

Part No.	Finish
IVS 0F 605	Polished Brass

**Hook Window Lift**

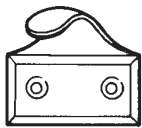

Solid Brass. 7/8" × 15/8" base. 20 per box.

Part No.	Finish
IVS 14-B-605	Polished Brass
IVS 14-B-626	Satin Chrome Plated

**Window Lock**

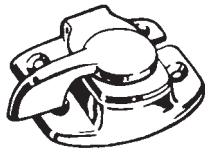

"Jimmy Proof". Burnished steel. 1<sup>3</sup>/<sub>8</sub>" × 2<sup>5</sup>/<sub>16</sub>" base. 9/16" × 2<sup>3</sup>/<sub>16</sub>" strike. 10 per box.

Part No.	Finish
IVS 4-F-605	Polished Brass

**Window Lock**



15/16" × 2<sup>5</sup>/<sub>8</sub>" base. 5/8" × 2<sup>5</sup>/<sub>8</sub>" strike.

Aluminum, 25 per box:

Part No.	Finish
IVS 07-A-92	Natural Aluminum
IVS 07-A-605	Polished Brass

Solid Brass, 10 per box:

Part No.	Finish
IVS 07-MB-605	Polished Brass
IVS 07-MB-625	Polished Chrome Plated

**Shutter Bar**

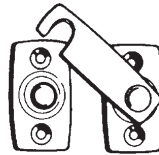

Solid Brass. Base 7/8" × 1<sup>1</sup>/<sub>2</sub>", hook centers 1<sup>3</sup>/<sub>8</sub>", 7/16" projection. 10 per box.

Part No.	Finish
IVS 31-B-626	Satin Chrome Plated

**Casement Fastener**

66A furnished with both MS and RS. 66B specify.

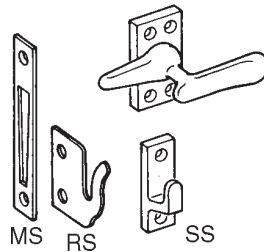

Aluminum, 10 per box:

Part No.	Finish	Base
IVS 66A605 RS MS	Pol. Brass	2 <sup>1</sup> / <sub>16</sub> " × 1 <sup>1</sup> / <sub>16</sub> "

Solid Brass, 10 per box:

Part No.	Finish	Base
IVS 66B605-RS*	Pol. Brass	2 <sup>1</sup> / <sub>16</sub> " × 1 <sup>1</sup> / <sub>16</sub> "
IVS 66B605-MS	Pol. Brass	2 <sup>1</sup> / <sub>16</sub> " × 1 <sup>1</sup> / <sub>16</sub> "
IVS 66B605-SS*	Pol. Brass	2 <sup>1</sup> / <sub>16</sub> " × 1 <sup>1</sup> / <sub>16</sub> "

Aluminum

Part No.	Finish	Base
IVS 066A605 RS MS	Pol. Brass	1 <sup>5</sup> / <sub>8</sub> " × 7/8"
IVS 066A605-SS	Pol. Brass	1 <sup>5</sup> / <sub>8</sub> " × 7/8"

Solid Brass, 10 per box:

Part No.	Finish	Base
IVS 066B605-MS*	Pol. Brass	1 <sup>5</sup> / <sub>8</sub> " × 7/8"
IVS 066B605-SS*	Pol. Brass	1 <sup>5</sup> / <sub>8</sub> " × 7/8"

\*F/O

**Casement Adjuster**



Steel. 5 per box. 3/8" diameter

Part No.	Finish	Length
IVS 71-F-605 10	Polished Brass	10"
IVS 71-F-605*12	Polished Brass	12"

\*F/O

**Friction Casement Adjuster**

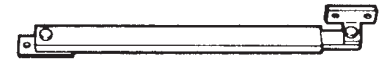

Solid Brass. 10 per box.

Part No.	Finish	Length
IVS 287-B-605 8	Polished Brass	8"

**Bar Window Lift**



Aluminum. 1<sup>1</sup>/<sub>8</sub> × 4", 1<sup>1</sup>/<sub>16</sub>" projection. 25 per box.

Part No.	Finish
IVS 026-A-92	Natural Aluminum

**Mortise Bolt**



Solid Brass. 1<sup>3</sup>/<sub>4</sub>" backset. 1/2" diameter bolt. 2<sup>1</sup>/<sub>2</sub>" × 9/16" case. 7/8" × 1<sup>3</sup>/<sub>4</sub>" strike.

15 per box.

Part No.	Finish	Throw
IVS 548-B-605	Polished Brass	1/2"

**Surface Bolt**



Both strikes included. 15 per box.

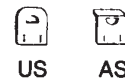

Solid Brass. 3/8" round rod:

Part No.	Finish	Length	Throw
IVS 043B-605 4	Pol. Brass	4"	3/4"
IVS 043B-626 4	Satin Chrm Plt	4"	3/4"

Steel. 3/8" round rod:

Part No.	Finish	Length	Throw
IVS 043-F-605 4*	Pol. Brass	4"	3/4"
IVS 043-F-605 6*	Pol. Brass	6"	3/4"

Solid Brass. 1/2" round rod:

Part No.	Finish	Length	Throw
IVS 43-B-605 6	Pol. Brass	6"	1"
IVS 43-B-609 6	Antique Brass	6"	1"

Ives 43B Sizes up to 12" on F/O  
Ives 043B Size down to 2" on F/O

\*F/O

**RESIDENTIAL HARDWARE**

**Dutch Door Bolt**

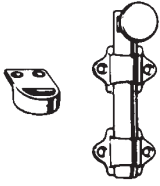

Solid Brass. Standard strike (shown) supplied. Mortise strike available on F/O. 5/8" half round rod, 1" diameter knob. 4 1/4" rod length. 5 per box.

Part No.	Finish
IVS 054-MB-605	---Polished Brass
IVS 054-MB-613	---Oil Rubbed Bronze
IVS 054-MB-626	---Satin Chrome Plated

**Crash Stop**

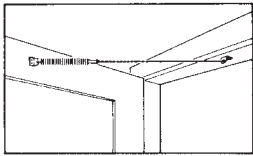

Wrought Steel Brackets, with Steel Chain. 22 3/4" in length. 3/4" spring diameter. 10 per box.

Part No.	Finish
IVS 15F 603	-----Zinc Plated

**Door Stop**



Steel. 50 per box.

Part No.	Finish	Projection
IVS 060-F-605	---Polished Brass	-----3"
IVS 060-F-612	---Satin Bronze	-----3"
IVS 060-F-613	---Oil Rubbed Bronze	-----3"
IVS 060-F-618	---Polished Nickel Plated	---3"

**Base Door Stop**



Aluminum. 20 per box.

Part No.	Finish	Projection
IVS 61-A-92	--Aluminum	-----3"

**Hinge Pin Door Stop**



Steel. 70°-100° door openings. 25 per box.

Part No.	Finish
IVS 69-F-605	-----Polished Brass
IVS 69-F-618	-----Polished Nickel Plated

**Hinge Pin Door Stop**



Aluminum. 85° - 125° door openings. 25 per box.

Part No.	Finish
IVS 70-A-605	-----Polished Brass

**Elbow Catch**



Burnished aluminum. 1 3/8" x 5/8" plate. 1 3/16" x 5/8" strike. 25 per box.

Part No.	Finish
IVS 2-A-92	-----Natural Aluminum
IVS 2-A-605	-----Polished Brass
IVS 2-A-612	-----Satin Bronze

**Finger Pull**



Solid Brass. 3/4" bore. 100 bags per box. Sold per bag of four.

Part No.	Finish
IVS 218-BB-605	---Polished Brass
IVS 218-BB-618	---Satin Nickel Plated

**Flush Pull**



Solid Brass. 1 1/2" bore. 20/box.

Part No.	Finish
IVS 225-B-626	-----Satin Chrome Plated

**Flush Pulls**



Solid Brass. 2 1/8" bore. 25 per box.

Part No.	Finish
IVS 221-B-605	-----Polished Brass
IVS 221-B-609	-----Antique Brass
IVS 221-B-613	-----Oil Rubbed Bronze
IVS 221-B-625	-----Polished Chrome Plated
IVS 221-B-626	-----Satin Chrome Plated

**Flush Ring Pull**



Solid Brass. 2 1/8" base. 10 per box.

Part No.	Finish
IVS 426-B-626	-----Satin Chrome Plated

**Flush Pull**



Solid Brass. 3 9/16" x 1 5/16" x 1/2". 10 per box.

Part No.	Finish
IVS 223-B-605	-----Polished Brass
IVS 223-B-613	-----Oil Rubbed Brz
IVS 223-B-626	-----Satin Chrome Plated

**Adjustable Catch**

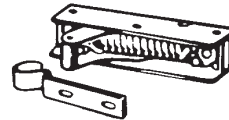

Steel, zinc finish.

Part No.	Dimensions	Quantity
IVS 350-F-603	-----4 x 1"	-----10 per box

**Door Edge Pull**



Solid Brass. 3 7/8" x 3/4" x 1 5/8". 10 per box.

Part No.	Finish
IVS 230-B-605	-----Polished Brass
IVS 230-B-613	-----Oil Rubbed Bronze
IVS 230-B-625	-----Polished Chrome Plated
IVS 230-B-626	-----Satin Chrome Plated

**Roller Catch**

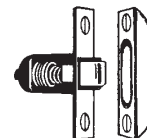

Solid Brass face plate and strike. 2 1/4 x 7/8" face plate, 3/4" bore. 10/per box

Part No.	Finish
IVS 335-B-605	-----Polished Brass
IVS 335-B-613	-----Oil Rubbed Bronze
IVS 335-B-626	-----Satin Chrome Plated

**RESIDENTIAL HARDWARE**

**Ball Catch**

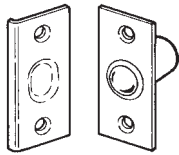

Solid Brass. 1 1/2" x 3/4" face plate.  
10 per box.

<b>Part No.</b>	<b>Finish</b>
IVS 345-B-605	Polished Brass
IVS 345-B-626	Satin Chrome Plated
Solid Brass. 2 1/8 x 1" face plate. 10 per box.	
<b>Part No.</b>	<b>Finish</b>
IVS 347-B-605	Polished Brass
IVS 347-B-626	Satin Chrome Plated

**Heavy Duty Magnetic Catch**

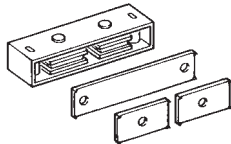

Aluminum case; dual double pole. 3 1/8" x 1" x 9/16".  
10 per box.

<b>Part No.</b>	<b>Finish</b>
IVS 326-A-92	Natural Aluminum

**1600 Series Surface Bolts**

*Concealed Mounting*

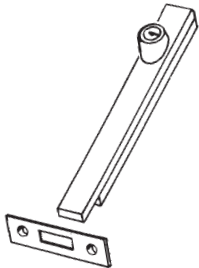

IVS SB1630 TL

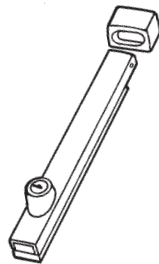

IVS SB1630 BL

Heavy duty steel (1630 models) or brass (1640 models). All units have a full 1" throw for maximum security and are ideal for all types of doors. UL listed for use on inactive door or a pair of doors up to 8' in height. Locking bolts are furnished with two keys, can be locked in up or down position. 1630 Series zinc plated, 1640 Series are F/O.

*Other Features:*

- Fully concealed mounting prevents vandalism.
- Units furnished with either universal top strike or flat bottom strike.
- Units packed with wood and machine screws to meet most field conditions.

<b>Part No.</b>
IVS SB1630 BL 603
IVS SB1630 TL 603

**Surface Bolt**

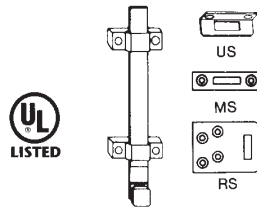

Steel. For use on labeled fire doors. UL Listed. 8" x 2 1/32" (5" and 12" available on F/O). 1 5/16" projection. 1 3/16" throw. Supplied with US and MS strikes. RS available on F/O at additional cost. 5 per box.

<b>Part No.</b>	<b>Finish</b>	<b>Length</b>
IVS SB454 8 TB 603	Zinc Finish	8"
IVS SB454 8 TB 612	Satin Bronze	8"

**Surface Bolt**

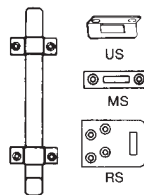

Steel. For use on labeled fire doors. UL Listed. 8" and 12" lengths (18" and 24" available on F/O). 2 1/32" width. 1 5/16" projection. 1 3/16" throw. Supplied with US and MS

strikes. RS available on F/O at additional cost. 5 per box.

<b>Part No.</b>	<b>Finish</b>	<b>Length</b>
IVS SB453 8 TB603	Zinc Finish	8"
IVS SB453 8 TB612	Satin Bronze	8"

**Heavy Duty Surface Bolt**

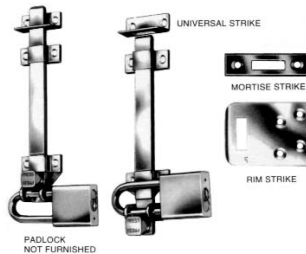

Steel. Designed for internal and external security. With eyes for locking with padlock. (Padlock not included). Packed with standard and one-way screws. 8" length. (5" length available on F/O.) 1 3/16" throw. Rim strike optional. 5 per box.

<b>Part No.</b>	<b>Finish</b>	<b>Length</b>
IVS SB0454 8TB 603	Zinc Finish	8"

**Flush Bolt**

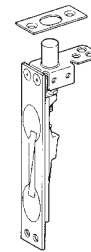

Solid Brass. 1" x 6 3/4" face-plate. For use on labeled wood covered composite fire doors not exceeding 1 1/2 hour fire rating and 10 feet in height. U.L. Listed. Two per box.  
• Standard for 1 3/4" thick wood door

<b>Part No.</b>	<b>Finish</b>
IVS FB358 613	Oil Rubbed Bronze
IVS FB358 626	Satin Chrome Plated

**Extension Flush Bolt**

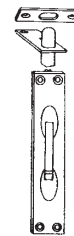

Solid Brass. 1 1/4" x 6 3/4" face-plate. 12" rod length. For use on labeled metal fire doors not exceeding 10 ft. in height and having a 3 hour fire rating. 2/bx

<b>Part No.</b>	<b>Finish</b>
IVS FB 457 612	Satin Brz
IVS FB 457 626	Satin Chrm Plt

**Flush Bolts**



Solid Brass. 4" x 3/4".  
10 per box:

<b>Part No.</b>	<b>Finish</b>
IVS 261-B-605	Polished Brass
Solid Brass. 6" x 3/4". 15 per box:	

<b>Part No.</b>	<b>Finish</b>
IVS 262-B-605	Polished Brass
IVS 262-B-613	Oil Rubbed Bronze
IVS 262-B-625	Polished Chrome Plated
IVS 262-B-626	Satin Chrome Plated

**ARCHITECTURAL HARDWARE**

**Manual Flush Bolt**

*For Metal Doors "Non-Handed"*

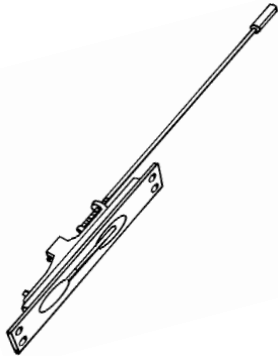

IVS FB458

IVS FB458 manual flush bolt with 12" rod, fits standard ANSI preparation for metal doors. Faceplate is 1 x 6<sup>3</sup>/<sub>4</sub>"

The FB458 is equipped with a spring loaded snap action lever. When the active door is opened, the lever can be moved to the "up" position, retracting the bolt and allowing the inactive leaf to be opened. When the inactive leaf is closed, the lever can be moved to the "down" position, projecting the bolt securely locking the inactive leaf.

The FB458 is non-handed, with a 5/8" throw. The standard rod length is 12", with 6, 9, 18, and 24" available on F/O. The FB458 is UL Listed for Fire Doors and made from forged brass.

- Part No.**  
 IVS FB458 605  
 IVS FB458 612  
 IVS FB458 613  
 IVS FB458 625  
 IVS FB458 626

**Flush Bolts**



Solid Brass. 6<sup>3</sup>/<sub>4</sub> x 3/4".  
 15 per box.

- Part No.**                      **Finish**  
 IVS 260-B-605----Polished Brass

**Automatic Flush Bolts**

*For Metal or Wood Doors*

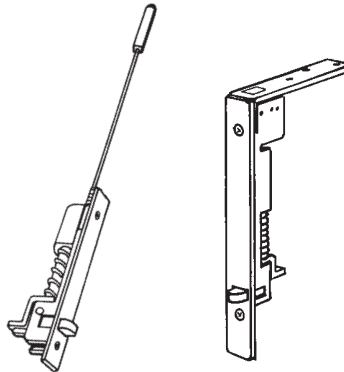

IVS FB31P

IVS FB41P

Reduced Activation Force

- Single Bolt Application — UL Listed for Fire Doors
- Non-Handed
- 3/4" throw with 7/8" vertical adjustment
- 12" Rod standard, 18, 24, 36 and 48" available on F/O (Non fire rated openings)

The FB31P for hollow metal doors contains an FB31T top bolt and an FB31B bottom bolt. These units are non-handed, but the top and bottom bolts are not identical. The top bolt has no spring tension and provides a significant reduction in activation force.

The FB41P for wood doors consists of an FB41T top bolt and an FB41B bottom bolt. These units are non-handed, but the top and bottom bolts are not identical. The FB41T top bolt has no spring tension and therefore provides a significant reduced activation force.

- Part No.**  
 IVS FB31P 613  
 IVS FB31P 630  
 IVS FB41P 613  
 IVS FB 41P 630

**Dust Proof Strikes**

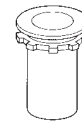

For use with all IVES automatic, self-latching and manual flush bolts. Spring tension is calibrated for positive closing and eliminates binding. For use on thresholds only. Solid Brass. Fits 1<sup>1</sup>/<sub>16</sub>" hole.  
 10 per box.

- Part No.**                      **Finish**  
 IVS DP1 613-----Oil Rubbed Bronze  
 IVS DP1 626-----Satin Chrome Plated

**Dust Proof Strike**

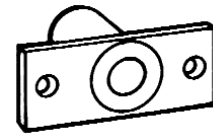

The DP2 is designed to work with all IVES flush bolts. Spring-loaded plunger returns to floor or threshold level anytime flushbolt is retracted, to end the need to stoop down and clean a floor strike.

- Part No.**  
 IVS DP2 612  
 IVS DP2 613  
 IVS DP2 625  
 IVS DP2 626

**Door Coordinator**

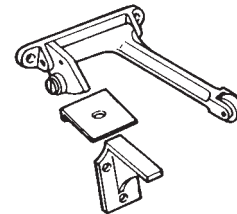

Solid Brass. Reversible, automatic coordinating device for use on pairs of doors to prevent the active door leaf from closing ahead of inactive door. Specifically designed for use on labeled fire doors in conjunction with IVES automatic or self-latching flush bolts.

- Surface mounted
- Six bolts required for door bracket for installations on wood covered composite 1<sup>3</sup>/<sub>4</sub>" thick labeled doors
- Exclusive design incorporating unique cam contour with assisting nylon roller reduces friction and increases efficiency of hardware system
- One per box

- Part No.**                      **Finish**  
 IVS COR7G 626-----Satin Chrome Plated

ARCHITECTURAL HARDWARE

COR Series Coordinators

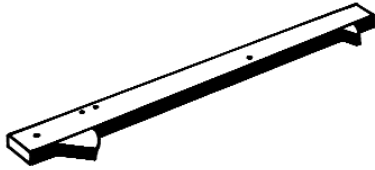

The COR Series Coordinators are designed for use on pairs of doors when one door needs to close before the other.

All COR units function easily. The active door lever, located nearest to the active stop, holds the active door ajar until the trigger mechanism is released to the retracted position by the closing of the inactive leaf. All COR units are equipped with a safety release mechanism which allows the active door to close if under extreme pressure, preventing damage to COR, doors or hinges. All COR's are compatible with IVS Automatic Flush Bolts, FB31 and FB41. IVS Coordinators and Flush Bolts have been tested a minimum of 100,000 cycles by an independent laboratory. The COR Series does not cover the entire length of the stop, so a filler bar can be provided to maintain architecturally clean lines. Specify FL20 for filler up to 20", FL32 up to 32".

Coordinators and fillers are made of aluminum. UL listed for installation on labeled frame.

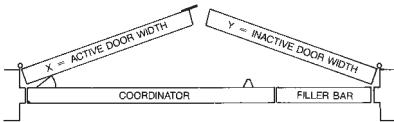

Part No.	Door Channel Length	Opening Range X & Y
IVS COR-32 628	32"	34"-52"*
IVS COR-42 628	42"	52"-72"*
IVS COR-52 628	52"	62"-92"
IVS COR-60 628	60"	70"-108"*
IVS COR-72 628	72"	84"-132"*

\* F/O

Filler Bars

Aluminum construction

Part No.	OA Length
IVS FL20 628	20"
IVS FL32 628	32"
IVS FL44 628	44" F/O

Mounting Brackets

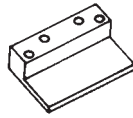

IVS MB1

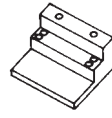

IVS MB2

Allows stop-mounted hardware, such as parallel arm closer on surface mounted vertical rod strike, to be properly installed without damaging the COR coordinator. Stop mounted hardware will need to be lowered to compensate for the height of the coordinator and mounting bracket. Use MB1 for stop width over 2 1/2", use MB2 for stop width up to 2 1/2". Prime coated.

Part No.

- IVS MB1 600
- IVS MB2 600

DOOR HOLDERS

Automatic Floor Door Holders

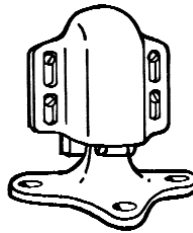

Forged of durable brass. Door position adjustable. Activation of unit is accomplished automatically when door is opened. A firm pull on the door releases the mechanism.

Furnished with strikes of varying heights to accommodate different door to floor clearances, these models are ideal for heavy traffic situations that require a simple, fool-proof hold open device. Units are furnished with universal screw pack to allow for installation in all types of construction.

Part No.

Door to Floor Clearance

- IVS FS40 626 ----- 1/2" or less
- IVS FS41 612 ----- 9/16 - 1 1/16"
- IVS FS41 626 ----- 1 1/8 - 1 9/16"
- IVS FS42 626 ----- 1 5/8 - 2 1/16"
- IVS FS43 626 ----- 1 5/8 - 2 1/16"

Manual Type Holder

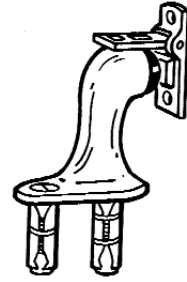

Constructed of heavy-duty cast brass. Matching strike features unique hinged hook which, when lifted, will engage the holder. By simply raising the hook, the door is then released, the hook dropping down flush with the strike plate. Resilient rubber tip.

- Packed with expansion shield and tamper
- Strike packed with sheet metal screws

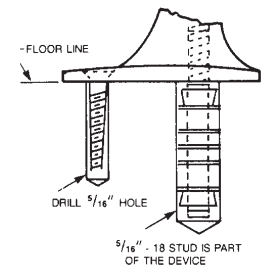
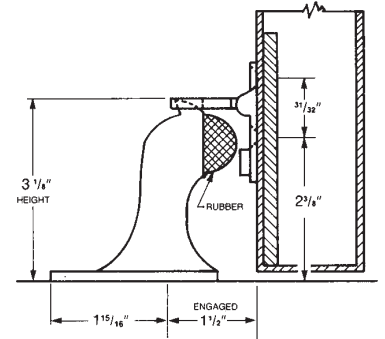

Part No.

- IVS FS451 613
- IVS FS451 626

Door Holder



Aluminum. 4" arm length. 15 per box.

Part No.

Finish

- IVS FS455 AL 605 ----- Polished Brass Plated
- IVS FS455 AL 612 ----- Satin Bronze Plated
- IVS FS455 AL 627 ----- Natural Aluminum

**Kick Down Door Holders**

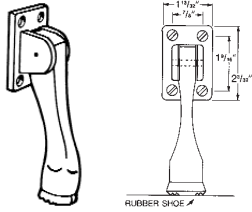

An attractive yet positive and economical method of hold-open. Cast of durable iron, these models are available in a variety of sprayed finishes, including bronze (SP10), brass (SP4) and aluminum (S28). Hold open and release are activated with a touch of the foot. Round non-marring rubber shoes have corrugated bottoms to provide secure grip and a shank which forms its own thread when screwed into threaded cavity of holder. When worn, shoes are easily replaced (see below). Ideal for use on all type of doors where door-to-floor clearance is 2".

**Part No.**  
 IVS FS 544 4 SP10  
 IVS FS 544 4 SP28  
 IVS FS 544 4 SP4

*Rubber Shoe only: (Pk 6)*  
 IVS FS544 Non-threaded  
 IVS FS544 Threaded

**PLUNGER DOOR HOLDERS**

**Door Holder**

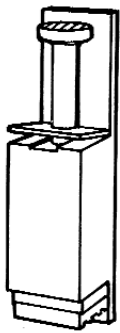

Provides a contemporary yet economical method of positive hold-open. Body is sturdy cast aluminum. Spring operated plunger activates with minimal pressure, releasing instantly with a light tap on the platform lever. Ribbed non-marring rubber shoe is securely fastened to unit and is easily replaced when worn.

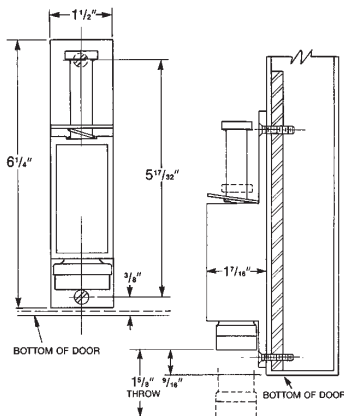

**Part No. Description**  
 IVS FS1153 628 -----Plunger Door Holder  
 IVS FS1153 RS -----Rubber Shoe only

**Door Holder**

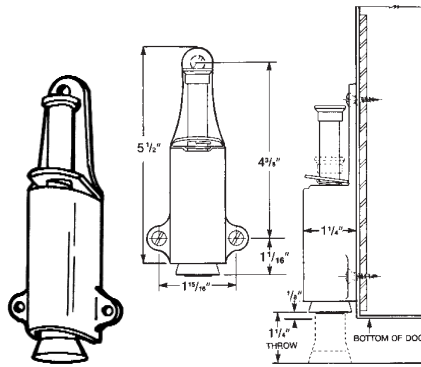

Combines conventional design with strength in an attractive cast brass or bronze body. Plunger and internal parts are plated steel and provide a 1 1/4" throw for all types of doors. Plunger is easily activated with minimal pressure, releasing instantly with a light tap on the platform lever. Round non-marring rubber shoe is securely fastened in flanged cup to prevent movement or loss. Rubber shoe is easily replaced when worn.

**Part No. Description**  
 IVS FS1154 612 -----Door Holder  
 IVS FS 1154 626 -----Door Holder  
 IVS FS1154RS -----Rubber Shoe only

**ROLLER BUMPERS**

**Roller Bumpers**

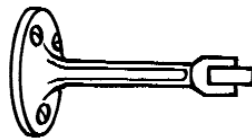

Heavy-duty cast brass. Used where two doors open against each other to prevent damage to the doors or hardware. These units, mounted along the top rail, feature solid rubber rollers securely fastened to the stem and 3 holes for positive mounting. Straight arm design with a round base, the RB471 projects 4 1/2" while the RB472 projects 6". These models are ideal for use in situations where doors meet each other at approximate right angles (back to back).

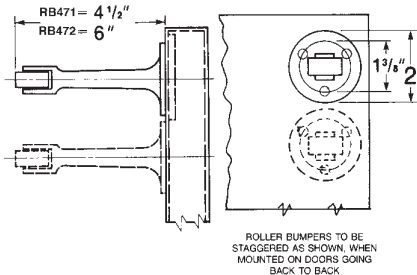

**Part No.**  
 IVS RB471 626  
 IVS RB472 626

**DOOR STOPS**

**Floor Mounted Stop**



Cast brass construction ideal for interior or exterior use. Packed with expansion shield and lead shield

**Part No.**  
 IVS FS 444 626

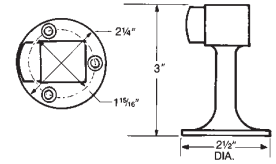

**Security Door Stop**

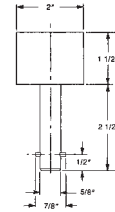
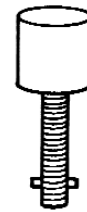

Designed for use in high vandalism areas. Molded from flame retardant, resilient material around a heavy duty stud which, once grouted in concrete, leaves no exposed fasteners to be tampered with or removed. Ideal for jail or security cell areas where floor mounted stops are required.

**Part No.** IVS FS 185

**LATCHES**

**Roller Latch**

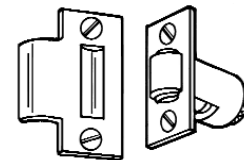

Ives RL32F Roller Latch is constructed of bronze or stainless steel and is designed to fit a heavy duty cylindrical lock mortise. Rugged cast unit features a solid brass roller (nylon covered for silencing). Normal closing of door engages roller in groove on strike, thereby holding the door shut. Unit is easily adjustable, allowing for variance in door clearance. Latches are provided standard with 2 3/4 x 1 1/8" strikes but are available with ASA (specify STK726).

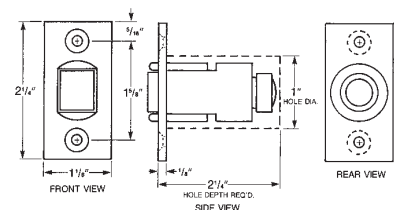

**Part No.**  
 IVS RL32F 630

LATCHES

Push Latch

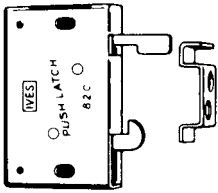

For lightweight cabinet doors  
Steel,  $25/16" \times 1\frac{1}{2}" \times 5/16"$ . 10 per box.

**Part No.** IVS 820-F-603  
**Finish** -----Zinc Finish

Invisible Latch

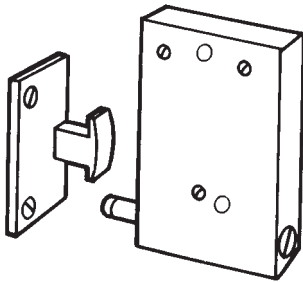

Ideal for installations where no visible latches are desired. Units can be installed at the top, bottom or side of the door and can be mounted flush in the door stop or on the surface of the stop. The CL11 latch is recommended for use on small panels, cabinet doors or light closet doors, while the CL12 latch is used on larger panels or regular size doors. Operation of both models is simple, with latching accomplished by a slight push. A harder push releases the door.

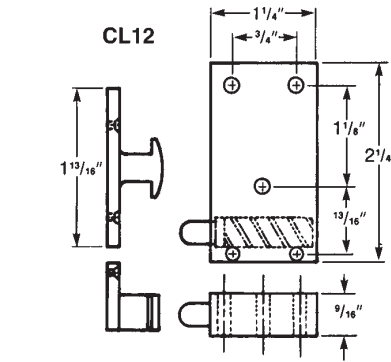
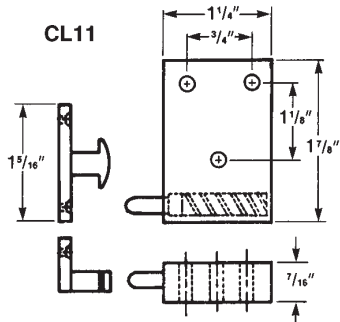

**Part No.**  
IVS CL11 612 F/O  
IVS CL12 612

Auxiliary Pusher

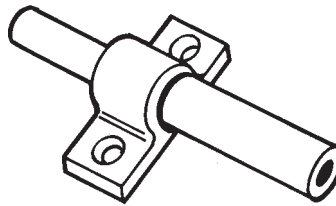

IVES CL14 Auxiliary Pushers are constructed of bronze designed to aid operation of CL11 or CL12 latch in cases where hinges or surrounding conditions prevent smooth operation of door. Provides full  $1\frac{1}{16}"$  throw.

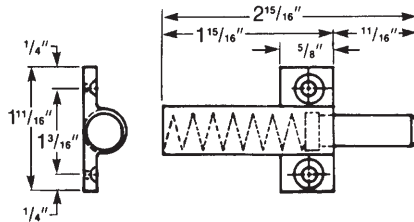

**Part No.**  
IVS CL14 612 F/O

Ball Type Latches

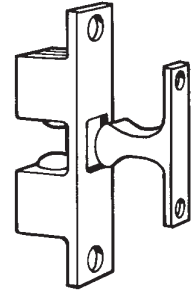

Ives CL21A is ideal for closet doors, access doors, hinged openings and numerous other applications. Unit is provided with a plate type strike. Strike can enter from any direction and can be surface mounted or mortised into frame. Tension of units is easily adjusted to meet field conditions. Brass construction.

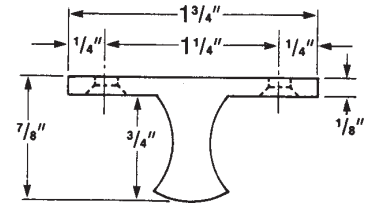

**Part No.**  
IVS CL21A 612  
IVS CL21A 626

**LATCHES**

**Ball Type Friction Latch**

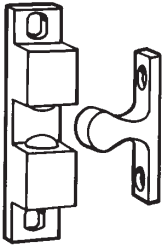

Brass construction Ideal for smaller cabinet doors or panels. Similar to Model CL21A in design but strike can enter only from front or either side. Tension of unit is easily adjusted to meet field conditions.

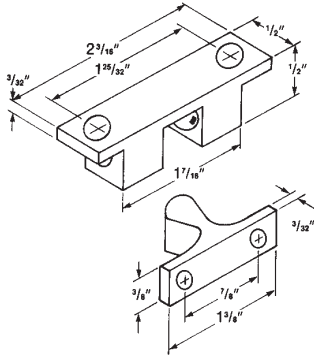

**Part No.**  
IVS CL22 612  
IVS CL22 626

**SILENCERS**

**Door Silencer for Metal Frames**



For use on metal frames featuring pneumatic design that, once installed, forms an air pocket to absorb shock and reduce noise of door closing. Tamper-proof once installed on the frame. Proper installation also eliminates door rattle and provides constant tension for door latches or locks. Gray color, packed in bags of 100.

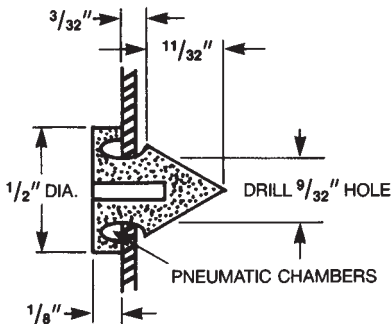

**Part No.**  
IVS SR64

**Door Silencer for Wood Frames**



For use on wood frames, also feature pneumatic design to cushion shock and absorb noise. To prevent removal, a small brad should be driven into stop strip and through stem of silencer, as shown in the detail. Gray color, packed in bags of 100.

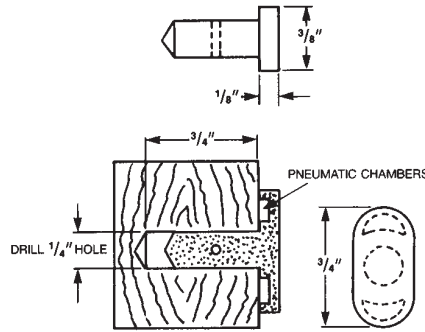

**Part No.**  
IVS SR65

**Coat & Hat Hook**

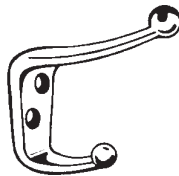

Aluminum. 2 1/2" projection. 25 per box.

**Part No.**                      **Finish**  
IVS 405-A-92 -----Natural Aluminum

**Coat & Hat Hook**



Aluminum. 3" projection. 25 per box.

**Part No.**                      **Finish**  
IVS 571-A-92 -----Natural Aluminum  
IVS 571-A-605 -----Polished Brass  
IVS 571-A-612 -----Satin Bronze

**Ceiling Hook**



Aluminum. 2 1/4" projection. 100 per box.

**Part No.**                      **Finish**  
IVS 580-A-92 -----Natural Aluminum

**Wardrobe Hooks**



Aluminum. 1 11/16" projection. 50 per box.

**Part No.**                      **Finish**  
IVS 581-A-92 -----Natural Aluminum

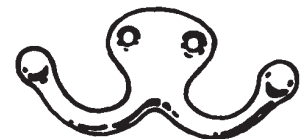

Aluminum. 1 1/8" projection. 50 per box.

**Part No.**                      **Finish**  
IVS 582-A-92 -----Natural Aluminum

**Mail/Magazine Slot**



Spring Loaded Front Plate



Standard Back Plate

Solid Brass or Aluminum. 2" x 11" opening. 3 9/16" x 13" overall dimensions. 1 per box.

**Part No.**                      **Finish**  
IVS 620-B-605 -----Polished Brass  
IVS 620-B-613 -----Oil Rubbed Bronze  
IVS 620-B-626 -----Satin Chrome Plated  
IVS 620-PA-628 -----Anodized Aluminum

**ARCHITECTURAL HARDWARE**

**Sex Bolt**



For mailbox plates. When applied to hollow core doors, these must be used. Poly bag set of four. Other finishes available on F/O.

Part No.	Finish
IVS 09-355-626	----Satin Chrome Plated

**Mail Slot Sleeves**

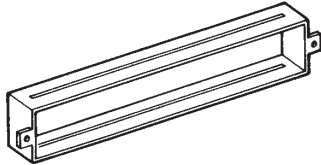

Stainless Steel. For 1<sup>3</sup>/<sub>4</sub>" doors. One per box.

Part No.	Description
IVS 601	-----For use with IVS 620

**Transom Catch**

2<sup>1</sup>/<sub>4</sub>" x 1<sup>1</sup>/<sub>4</sub>". US=Universal Strike; AS=Angle Strike; RS=Rim Strike.

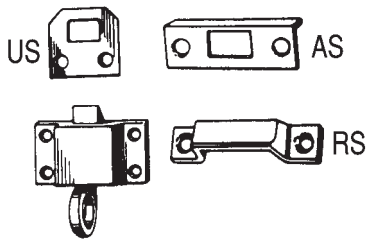

Aluminum, 10 per box:

Part No.	Finish
IVS 80-A-92 US	----Natural Aluminum
IVS 80-A-605 AS	---Polished Brass
IVS 80-A-605 US	---Polished Brass

Solid Brass, 10 per box:

Part No.	Finish
IVS 80-B-605 US	---Polished Brass

**Transom Chain**



Steel. 10" or 15" lengths available on F/O. Other finishes available on F/O. 10 per box.

Part No.	Finish	Length
IVS 82 F605 12	-----Polished Brass	-----12"

**Handrail Bracket**

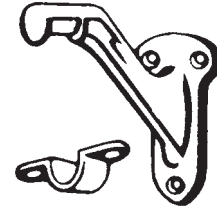

Aluminum. 2<sup>13</sup>/<sub>16</sub>" x 1<sup>1</sup>/<sub>2</sub>" base. Base to center of rail measures 2<sup>3</sup>/<sub>4</sub>". 50 per box.

Part No.	Finish
IVS 59-A-92	-----Natural Aluminum
IVS 59-A-605	-----Polished Brass
IVS 59-A-609	-----Antique Brass

**Handrail Bracket**

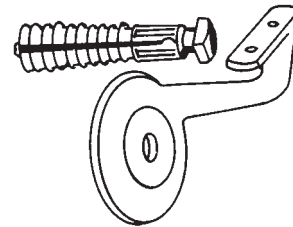

Aluminum. Base to center of rail measures 3<sup>1</sup>/<sub>8</sub>" 5 per box.

Part No.	Finish
IVS HB159A92	-----Natural Aluminum