

KEY MACHINES

Blue Shark

Stand-alone Hand Activated Robotic Key Machine



HPC's new BlueSHARK™ is a revolution in key cutting! The Blue SHARK™ is the world's 1st computerized touch screen key machine. The machine comes fully loaded with an updatable internal database of HPC's code library including Vehicle, Padlock, and Lockshop codes. Plus, it has the ability to add Custom DSDs (depth and spacing data) to this already extensive database. It also has the ability to download information from MasterKing®, KeyTrail®, and Code Source® directly from a PC. All of this information and much more is controlled through the touch screen on the Blue SHARK™. This touch screen (approx. 4³/₄ × 2¹/₂"") is large enough to give the user multiple options on one screen and save the headache of constantly flipping back and forth between screens.

The specially designed 4-way jaws enable the Blue SHARK™ to hold the greatest number of different blanks. The electronic Safety Switch on the tip and shoulder gauge prevents the cutting of keys if either gauge is up. The machine is based on an X-Y table that allows for an expansive range of depths and spaces.

The biting field accommodates double cuts used in Medeco® master key systems, and the cutter head pivots automatically to make high security angle cuts.

An electronic touch-off allows user to cut double-sided metal automotive keys accurately by code. A built-in decoder read depth of a cut key and displays the information on screen. From here, a new blank can be inserted and cut to the same or an adjusted biting.

Technical Information:

Motor: 120VAC (1/6 H.P., 4 Amps.)
 Weight: 96 lbs.
 Machine Size: 16.25"W × 16.25"D × 23"H
 Bench Size: 24"W × 20"D

Part No.
 HPC 123SHARK F/O

Cutters Supplied:

HPC CW-14MC, HPC CW-1011, HPC CW-90MC, HPC CW-47MC, HPC CW-1012, HPC CW20FM

Accessories Included:

Part No.	Description
HPC Cable-25S	Cable (for use with software)
HPC CMB-CKDISC	Calibration Disk
HPC SHARK-21	Calibration Key
HPC SHARK-20	Cutter Light
HPC WRENCH-7	Cutter Nut Wrench (90° angle)
HPC SHAKR-18	Decoder Plate
HPC 123SHARK-MAN	Manual
HPC QN-100B	Quick Nut
HPC 123SHARK-CD	Restore/Calibration CD
HPC SHARK-19	Safety Shield
HPC TYX-3	Softie™ Brush
HPC CM-1039MA	Standard Cutter Nut
HPC SHARK-14	Stylus

Optional Accessories Available:

Part No.	Description
HPC BEST-1S	Best Jaw
HPC MJ-3S	Medeco®3 Freedom Jaw
HPC MJ-2S	Medeco® KeyMark® Jaw
HPC SPR-5	Spacer for Safe Deposit Box Keys
HPC TIBBE-SHARK	Tibbe Adapter
HPC TKA-SHARK	Tubular Adapter

Optional Cutters Available:

Part No.	Description
HPC CW-32MC	Tool Steel, 90° Assa
HPC CW-105	Tool Steel, 105° Double Angle
HPC CW-1013	Tool Steel, 90° Emhart
HPC CW-1014	Tool Steel, 100° Kwikset
HPC CW-45SMS	Tool Steel, .045 Side Mill Slotter
HPC CW-EC	Carbide, .069 Diebold Slotter
HPC CW-CC	Carbide, .058 Lloyd Matheson Slotter
HPC CW-FC	Carbide, .088 Mosler Slotter
HPC CW-DC	Carbide, .064 S & G Slotter
HPC CW-BC	Carbide, .054 Yale Slotter

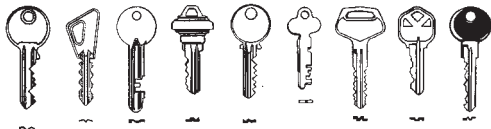
KEY MACHINES
The Codemax™ — The Original Computerized Code Machine

The HPC Codemax™. 1200 Series Code Machine taken to the next level. Code key generation and reproduction are done automatically and accurately using machine stored manufacturers' dimensions.

Comes equipped with an internal computer chip containing over 900 different depth and spacing charts, which allow it to cut the majority of keys worldwide. Has the ability to handle keys of up to 14 spaces and 14 depths. Codemax comes with five cutter wheels. Plus, Codemax performs automatic widening of cuts when necessary. With the optional Medeco® cutter (HPC CW-1012) and jaw (HPC MJ-1), Codemax is ready to cut Medeco Biaxial.

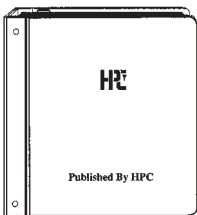

The easy-to-use reference manual makes it simple to look up the proper Depth and Spacing chart by lock manufacturer, 1200CMB card number or by Codemax number. By pressing the DSD# button and entering the correct number, Codemax will tell you the manufacturer and inform you of the proper gauging point. It then allows you

to enter the depths of your choice. Once this has been done, Codemax will create an original key in as little as 15 seconds. Codemax also has a built-in micrometer function, with both inch and millimeter modes. This allows Codemax to function as a true micrometer machine utilizing any Depth and Spacing measurements. Codemax is a complete stand-alone unit. **It becomes even more powerful when attached to your computer using HPC software.** HPC currently produces four software programs to take advantage of Codemax's power. These programs allow Codemax to receive up to 250 keys in as little as 5 seconds.

Codemax is a superb machine designed for the progressive security professional. Supported by the HPC Technical Support Department, which assures you of prompt, knowledgeable and friendly service.

Part No.
HPC 1200MAX
Available F/O

The Codemax™ — AA

The original Computerized Code Machine now available with the automatic angler! Just type in the code and watch the new motor-driven swivel head automatically create high security angle cuts.

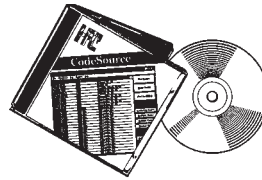

CodeMax comes with a copy of HPC's CodeSource. It has a database of well over 2 million codes that can be accessed quickly and easily from your Windows based PC.

Technical Information:

Motor: 120VAC (1/6 H.P., 4 Amps.)
 Weight: 46 lbs.
 Cutters Supplied: HPC CW-14MC, HPC CW-1011, HPC CW-90MC, HPC CW-20FM, HPC CW-47MC
 Machine Size: 12"W x 14"D x 14"H
 Bench Size: 20"W x 14"D

Accessories Included:

Part No.	Description
HPC CS-CD	CodeSource
HPC CM-1054R	Horseshoe Tip Stop
HPC CN-1054MA	Red Tip Stop
HPC CABLE-25S	Cable (for use with software)
HPC WRENCH-1	Cutter/Adjustment Wrench
HPC WRENCH-2	Space Adjustment Wrench
HPC WRENCH-3	Cutter Nut Wrench
HPC HDSB-CD	Interactive Depth & spacing Guide
HPC Manual	

Optional Accessories Available:

Part No.	Description
Additional Software:	
HPC KC-CD	Key Choice
HPC KT-CD	Key Trail
HPC MK-CD	MasterKing
HPC SPJ-1	Schlage Primus®/Quad Jaw
HPC MJ-1	Medeco® Jaw
HPC HKD-75	Key Decoder
HPC HT-SD & HPC RT-SD	Tip Stops for Safety Deposit Box Keys
HPC HT-125 & HPC HT-625	Tip Stops for for K&F Safe Deposit Box Keys
HPC SPR-5	Spacer for Safety Deposit Box Keys
HPC KBPS-1	Brass Plated Key Shim

Optional Cutters Available:

HPC CW-1012, HPC CW-1013, HPC CW-32MC, HPC CW-1014, HPC CW-105, HPC CW-45SNS, HPC CW-BC (carbide), HPC CW-CC (carbide), HPC CW-DC (carbide), HPC CW-EC (carbide), HPC CW-FC (carbide).

Part No.
HPC 1200 MAX-AA
Available F/O

KEY MACHINES

The Blitz™ — Code Milling Key Machine

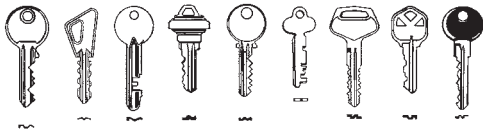

The Blitz™ is HPC's upgraded version of the 1200CM Code Machine. It works exactly the same as the 1200CM, but has several added features. Both the depth and spacing shafts have fewer threads per inch, which means that substantially less revolutions are needed to achieve the full range of travel. Other added features include a flip gauge that is more visible and easier to grasp. Plus, the Blitz™ Code Machine is equipped with HPC's Softie™ deburring brush with a safety shield.

This revolutionary code milling machine has made all others obsolete and is now the "Standard of the Industry". The Blitz™ is very simple to use and extremely versatile. It cuts by actual manufacturer's depths and spaces. There is no need to convert to micrometer readings.

This machine cuts accurate keys by code quickly and easily. The ease of changing from one manufacturer's specifications to another's is so simple, it is unparalleled. Even radically different changes can be set up in 10 to 30 seconds without wasting any key blanks.

This dramatic code cutting advancement is made possible through the use of code cards, which are inserted in the code machine. These cards have depth and space indicators, plus all the pertinent information such as cutters, jaws, code series, blanks and any special information you may need. Quite often, just replacing a code card is all that is required to change from one manufacturer to another. Depth and space adjustments are never required when changing from one manufacturer to another. The Blitz™ Code Machine is a must for those who create master key systems or do code work.

For those people who currently own a 1200CM style key machine and want to upgrade to a Blitz™, HPC has just such a conversion program. Call for details.

Technical Information:

- Motor: 120VAC (1/6 H.P., 3.5 Amps.)
- Weight: 30 lbs.
- Cutters Supplied: HPC CW-14MC & CW-1011
- Machine Size: 12"W x 14"D x 9"H
- Bench Size: 20"W x 14"D

Accessories Included:

Part No.	Description
HPC CSCD LITE	Code Source Lite
HPC DECK-150	Code Cards (142 code cards/8 micrometer cards)
HPC KBPS-1	Brass Shim on Chain
HPC CM-1054R	Horseshoe Tip Stop
HPC CARD-B	Binder (for 120 cards) with Manual
HPC WRENCH-1	Depth Adjustment/Cutter Wrench
HPC WRENCH-2	Space Adjustment Wrench
HPC WRENCH-3	Cutter Nut Wrench
HPC CM1054MA	Red Tip Stop Manual
HPC TYX-3	Brush

Optional Accessories Available:

Part No.	Description
HPC HKD-75	Key Decoder
HPC CMC-1	Code Machine Console
HPC CARD-BP	Card Panels (30's)
HPC MJ-1	Medeco® Jaw
HPC 1200 CASE	Case
HPC MAC-CM	Little Mac™ Card Making Unit
HPC HT-SD &	
HPC RT-SD	Tip Stops for Safety Deposit Box Keys
HPC SPR-5	Spacer for Safety Deposit Box Keys
HPC DECK 25	Code Cards (not included with 1200CMB, included with 1200 CMBX)
HPC TKA-CMB	Tubular Key Cutting Adapter
HPC CMB-CK	Calibration Kit

Optional Cutters Available:

HPC CW-1012, HPC CW-1013, HPC CW-90MC, HPC CW-20FM, HPC CW-32MC, HPC CW-47MC, HPC CW-1014, HPC CW-BC (carbide), HPC CW-CC (carbide), HPC CW-DC (carbide), HPC CW-EC (carbide); HPC CW-FC (carbide)

Part No.	Description
HPC 1200B	Key Machine Only (no accessories)
HPC 1200CMB	Key Machine with accessories listed above

Key Machine "Extreme Blitz"

Includes all the accessories of the 1200CMB plus:

- CSCD CodeSource Plus Software (instead o CSCD Lite)
- MKCD MasterKing Software
- HT-CMK1 "How to Create Master Key Systems Software"
- DECK-25 Additional 25 Code Cards
- TKA-CMB Tubular Key Cutting Adapter
- CMB-CK Calibration Kit

Part No.	Description
HPC 1200CMBX	Key Machine "Extreme Blitz"

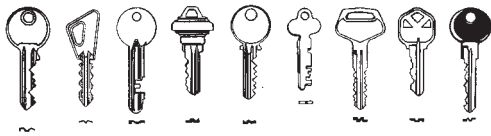
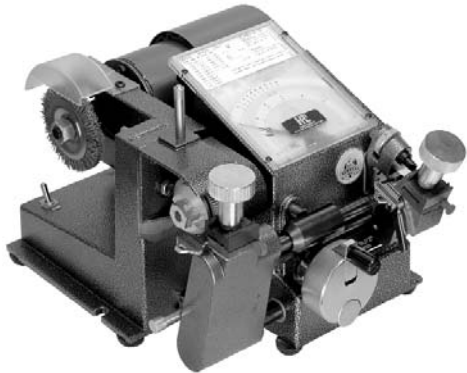
KEY MACHINES
Switch Blitz™
Code Machine & Duplicator

The new Switch Blitz™ combines the best of both worlds. the Original Blitz™ code machine combined with a heavy-duty semi-automatic duplicator. Now in the bench space of 1 machine you have 2 top-quality key machines. It cuts by code just like the Original Blitz™. No tools are needed, and not adjustments are required to the machine to switch from code cutting to duplicating and back again.

The new Switch Blitz™ is equipped with the latest features. It comes with the unique Quick Nut that allows for changing cutters without the use of any tools. The left-hand jaw is furnished with the new Easy Flip Shoulder Gauge handle. This new handle makes it easier to raise and lower the shoulder gauge. The machine also has the Safety Switch on the shoulder gauge that prevents the machine from powering on if the shoulder gauge is not all the way in the down position.

The motor on the Switch Blitz™ is a high performance model that provides ample torque for cutting.

The machine is supplied with an expanded deck of 150 code cards including many cards for the latest cars.

The Switch Blitz™ is truly 2 world-class key machines in 1. If you need a machine for your van or only have space for one machine, or you are ready to buy your first key machine, the Switch Blitz™ is the best option available.

Technical Information:

Motor: 120VAC (1/6 H.P., 3.5 Amps)
 Machine Size: 12"W x 14"D x 9" H
 Bench Size: 20"W x 14"D
 Weight: 39 lbs.

Cutters Supplied:

HPC CW-14MC, HPC CW-1011, HPC CW-6010

Accessories Included:

Part No.	Description
HPC CARD-SB-----	Binder (for 150 cards) with Manual
HPC KBPS-1-----	Brass Plated Key Shim
HPC DECK-150-----	Code Cards (150)
HPC WRENCH-1-----	Cutter/Adjustment Wrench
HPC WRENCH-3-----	Cutter Nut Wrench

HPC CM-1054R-----	Horseshoe Tip Stops (2)
HPC CM1054MA-----	Red Tip Stops (2)
HPC TYX-3-----	Softie™ Brush
HPC WRENCH-2-----	Space Adjustment Wrench

Optional Accessories Available:

Part No.	Description
HPC CMB CK-----	Calibration Kit
HPC CARD-BP-----	Card Panels (40 capacity)
HPC MJ-3-----	Medeco® 3 Freedom Jaw
HPC MJ-1-----	Medeco® Jaw
HPC MKYM-KIT-----	Medeco KeyMark® Kit
HPC SPJ-1-----	Schlage Primus®/Quad Jaw
HPC 1200 CASE-----	Soft Carrying Case
HPC SPR-5-----	Spacer for Safe Deposit Box keys
HPC TIBBE-SWITCH-----	Tibbe Key Adapter
HPC HT-SD & RT-SD-----	Tip Stops for Deposit Box Keys
HPC HT-125 & HT-625-----	Safe Deposit Box Keys
HPC TKA-SWITCH-----	Tubular Key Adapter

Part No.: HPC 1233CMSB

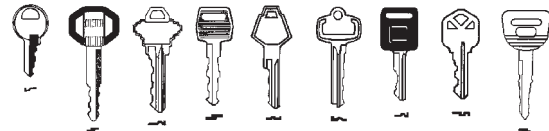
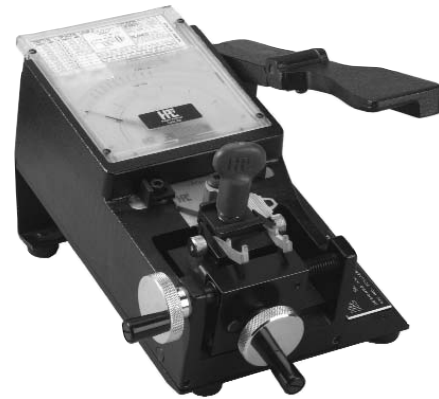
The Punch Machine™ — Code Punch

The Punch Machine™ works on the same principle as the 1200CMB, making it the most versatile punch machine on the market. Extremely accurate and completely portable. Depth and space adjustments are not required in changing from one manufacturer to another. Ready to cut most commercial, residential, automotive and furniture keys right out of the book. The punch machine is a must to create original keys where electricity is not available.

Technical Information:

Punches Supplied: PCH-1011, PCH-47 & PCH-14
 Machine Size: 9"W x 12"D x 6 1/4" H
 Bench Size: 9"W x 12"D
 Weight: 20 lbs.

Accessories Included:

Part No.	Description
HPC PDECK-101-----	97 code & 4 micrometer Cards Wrenches & Manual

Part No.: HPC 1200PCH

KEY MACHINES

Power Speedex® Semi-Automatic Key Duplicator

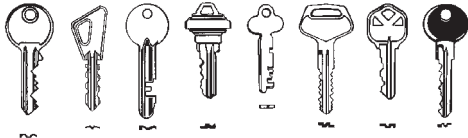
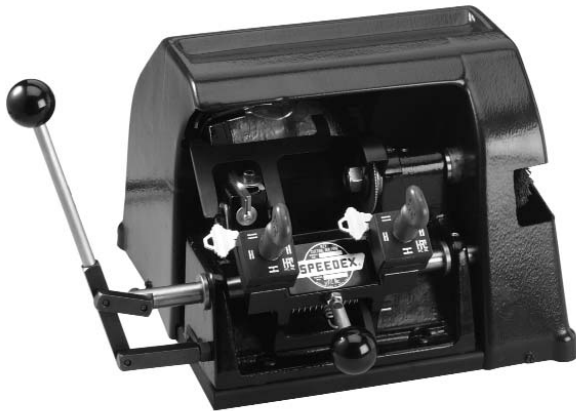

The **Power Speedex** is a semi-automatic duplicator that is operated by a spring-loaded carriage with safety release. This design allows the carriage to move smoothly with the use of one hand when cutting keys. The 9180MC also has a built-in light and a molded plastic cover that encloses the motor. It has 4-way jaws enabling it to hold a large variety of different key blanks, including double sided keys (such as foreign automotive keys) and large bow keys (such as hotel/motel keys). The reversible copy dog allows you to cut flat steel keys with the optional slotting cutter kit (HPC CW-16KIT). The simplicity of operating this machine makes easy work out of duplicating even a large number of keys. The 9180MC is mounted on a sturdy base and comes equipped with the HPC Softie™ rotary brush. Its durable construction and bronze bearings combine for a long lasting, accurate machine.

Technical Information:

Motor: 120VAC (1/6 H.P., 3.5 Amps.)
 Weight: 35 lbs.
 Cutter Supplied: HPC CW-23MC
 Machine Size: 13"W x 16"D x 10"H
 Bench Size: 18"W x 19"D

Optional Cutters Available:

HPC CW-16KIT: Flat Steel Conversion Kit
 (includes washer 9100-6B)
 HPC CW-45SMS: Flat Steel Slotter
 HPC CW-50MC: Tool Steel, Double Angle
 (requires optional tracer 9100-23B)
 HPC CW-34TS: Tool Steel, Single Angle
 (requires optional tracer 9120-13)

Part No.
 HPC 9180MC

Premier Speedex® Manual Key Duplicator

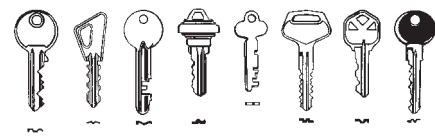
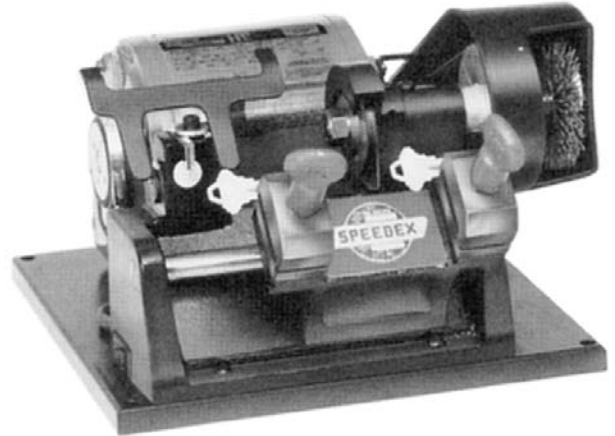

The **Premier Speedex** is a manual duplicator, perfect for duplicating even the largest of keys, such as hotel/motel room keys. It is equipped with the finest set of 4-way jaws available, ensuring accurately cut keys on the first try. The reversible copy dog allows you to cut flat steel keys when the optional slotting cutter kit (HPC CW-16KIT) is purchased. The simplicity of operating this machine makes easy work out of duplicating even a large number of keys. The 9160MC is mounted on a sturdy base and comes equipped with a heavy-duty motor. It also comes equipped with the HPC Softie™ rotary brush. Its durable steel construction and bronze bearings combine for a longer lasting machine.

Technical Information:

Motor: 120VAC (1/6 H.P., 3.5 Amps.)
 Weight: 32 lbs.
 Cutter Supplied: HPC CW-23MC
 Machine Size: 12"W x 14"D x 8"H
 Bench Size: 17"W x 17"D

Optional Cutters Available:

HPC CW-16KIT Flat Steel Conversion Kit
 (includes washer 9100-6B)
 HPC CW-45SMS Flat Steel Slotter
 HPC CW-50MC Tool Steel, Double Angle
 (requires optional tracer 9100-23B)
 HPC CW-34TS Tool Steel, Single Angle
 (requires optional tracer 9120-13)

Part No.
 HPC 9160MC

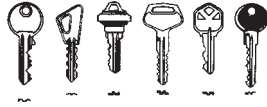
KEY MACHINES
Mini Speedex® Lightweight Key Duplicator

The Mini Speedex is the most accurate small key machine on the market. The 9120RM has 4-way jaws which allow it to cut a wide variety of keys. This lightweight duplicator is able to cut regular or large-bow keys. It also comes equipped with the HPC Softie™ rotary brush. The durable construction and bronze bearings combine for a longer lasting machine. Its portable size and weight make the 9120RM convenient to use almost anywhere.

Technical Information:

Motor: 120VAC (1/10 H.P., 1.5 Amps.)
 Weight: 16 lbs.
 Cutter Supplied: HPC CW-23RM
 Machine Size: 11"W × 8"D × 8"H
 Bench Size: 16"W × 11"D

Part No.
 HPC 9120RM

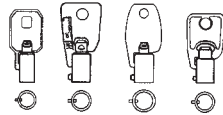
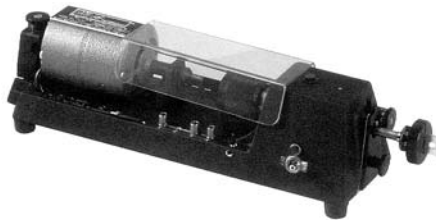
HPC/Scotsman Tubular Duplicode™
Multi-Functional Tubular Code Machine & Duplicator

The Tubular Duplicode™ is the preeminent tubular key machine. It will cut most of the popular sizes of tubular keys by code, including standard, oversize, and small bore. It accommodates 8-10, & 11-cuts, right & left hand cuts, dead pin cuts, and pin-within-a-pin cuts. It can also duplicate a wide variety of keys with any space and depth configuration. The Tubular Duplicode™ is equipped with a carbide cutter and a safety shield with a cut-off switch. This is an extremely versatile machine that will handle virtually all tubular code cutting and duplicating.

The 747XU will cut:

Standard size: .375" O.D./ .312" I.D.
 Oversize: .400" O.D./ .330 I.D.
 Small size: .365" O.D./ .300" I.D.
 Pin within a Pin .400" O.D./ .330 I.D.

Technical Information:

Motor: 115V AC (1/15 H.P., 2 Amps.)
 Weight: 10 lbs.
 Cutter Supplied: HPC 22-01 (carbide)
 Machine Size: 16"W × 4 1/2"D × 4 1/2"H
 Bench Size: 20"W × 6"D

Accessories Included:

Part No.	Description
HPC 11-08 -----	Alignment for cutter adjustment
HPC 25-07 -----	Code position Indicator Assembly
HPC Wrench-4 -----	Allen Wrench
HPC Manual	

Part No.: HPC 747XU

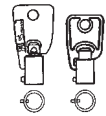
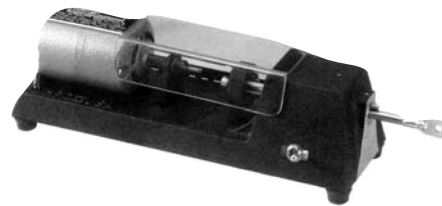
Econo Tubular Duplicut™
Economic Tubular Key Duplicator

The HPC/747E is a standard tubular key machine. It duplicates standard 7-Pin tubular keys in any position or any depth. It can also duplicate a key from an HPC tubular pick with the feelers in the picked position. The Econo Duplicut™ provides an economical standard size tubular key cutting solution.

The 747E will cut:

Standard size: .375" O.D./ .312" I.D.

Technical Information:

Motor: 115VAC (1/15 H.P., 2 Amps.)
 Weight: 10 lbs.
 Cutter Supplied: HPC 22-01 (carbide)
 Machine Size: 16"W × 4 1/2"D × 4 1/2"H
 Bench Size: 20"W × 6"D

Accessories Included:

Part No.	Description
HPC 32-35 -----	Wrench
HPC WRENCH#4 -----	Allen Wrench
Manual	

Part No.: HPC 747E

HPC/Scotsman Tubular Key Machine Cutter



Part No.
HPC 22-01

Tubular Key Blanks

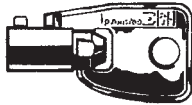

- .375" outside diameter; .312" inside diameter
- Available in boxes of 50

Part No.	Description
HPC 137	All steel construction with nickel plating standard
HPC 137B	Unplated brass body with nickel plated steel head

Tubular Key Adapter Kit



This adapter allows you to convert your 1200MB Blitz™, Switch Blitz™, or Blue SHARK™ into a tubular key cutter. It is factory preset to cut standard 7-pin tubular keys (.365 O.D.) by code. The Tubular Key Adapter fits in the standard jaw making conversion quick and easy. The kit comes with an Adapter, Carbide Slotter Cutter, a Code card (with the Blitz™ and switch Blitz models), and an Allen wrench. Plus, with the included Tubular Key decoder, you can quickly decode existing tubular keys and make new factory originals by code. Fast, easy, accurate and economical, a valuable addition to your cutting equipment.

Part No.
HPC TKA-CMB

Blitz™ Series Calibration Kit

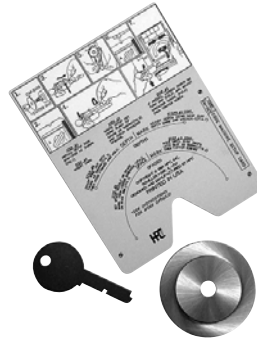

This easy to use tool kit is for use with all 1200CM Blitz™ and Switch Blitz™ code machines. It is designed to quickly and accurately diagnose whether your machine is out of calibration. If it is out of calibration, the kit can then be used to calibrate your machine with just a few simple steps, or determine whether factory service is needed. This kit makes it easy to calibrate your machine, and helps to eliminate unnecessary downtime.

Part No.
HPC CMB-CK

1200CMB Code Cards

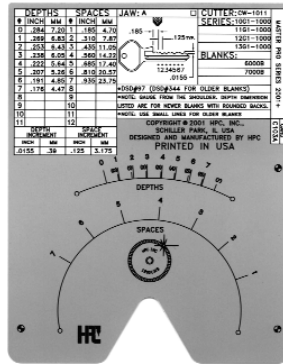

There are over 100 Code Cards available for both the 1200CMB and the 1200PCH. They are updated on an ongoing basis. Please check with our sales staff for availability. The cards are not interchangeable, so be sure to specify which machine you are ordering them for.

1200 SERIES CUTTERS

Small Cylinder Cutter. 90° Angle

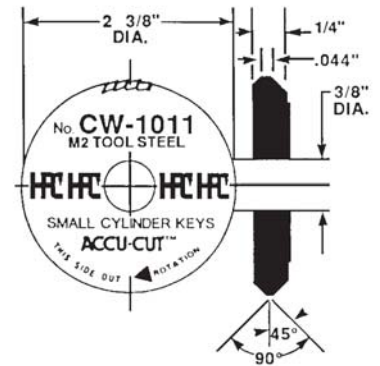

Part No.
HPC CW-1011

Optional Milling Cutter

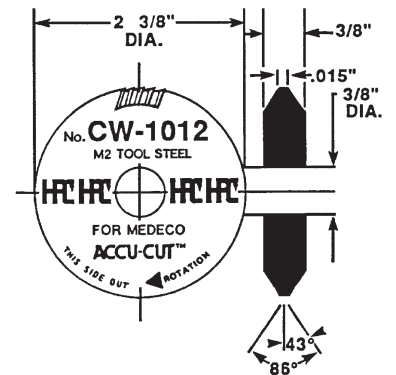

Optional milling cutter has angle and pin seat as required for cutting Medeco® High Security keys.

Part No.
HPC CW-1012

Standard Large Cylinder Cutter

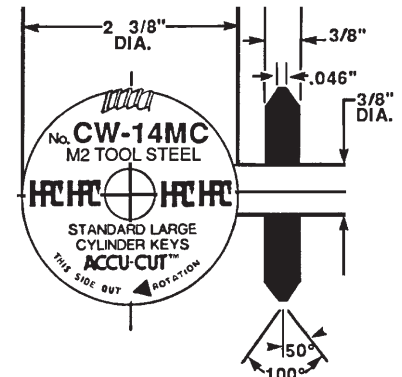

Standard large cylinder cutter. 100° angle.

Part No.
HPC CW-14MC

Double angle

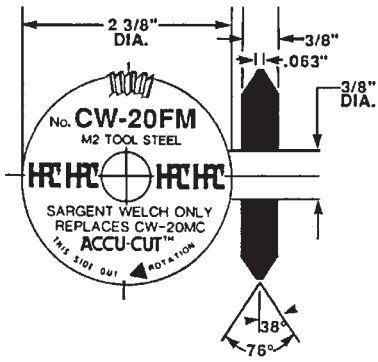

Double angle, flat mill tooth for Sargent. 76° angle.

Part No.
HPC CW-20FM

Tool Steel Cutter

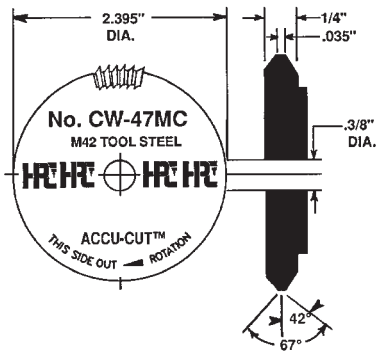

Tool steel cutter for some automotive requiring an 87° angle.

Part No.
HPC CW-47MC

Cut Large Cylinder Keys

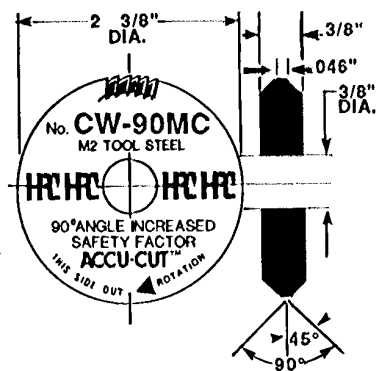

Enables you to cut large cylinder keys with shallow and deep cuts in adjacent positions. 90° angle. For Best, Falcon, Eagle, Arrow, Kaba and I/C core.

Part No.
HPC CW-90MC

1200 Series Slotter Cutter

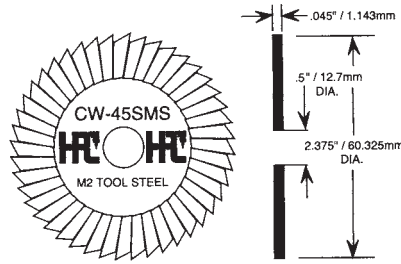

.045" M2 tool steel combination standard/flat steel cutter for safe deposit boxes (requires spacer SPR-5 with 1200 Series machines only).

Part No.
HPC CW-45SMS

SPEEDEX SLOTTOR CUTTERS

Flat Steel Conversion Kit

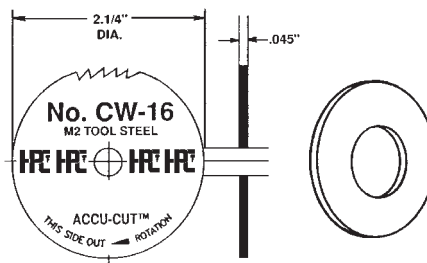

This Flat Steel Conversion Kit converts 9160MC and 9180MC Key Machines from standard to flat steel duplicators. Comes with CW-16 cutter and 9100-6B washer.

Part No.
HPC CW-16KIT

Replacement Slotter Cutter

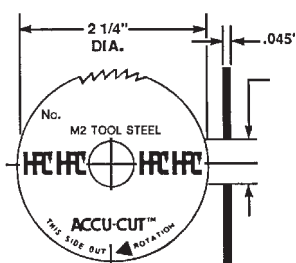

Replacement tool steel slotter cutter for CW-16KIT.

Part No.
HPC CW-16

Speedex Single Angle Cutter

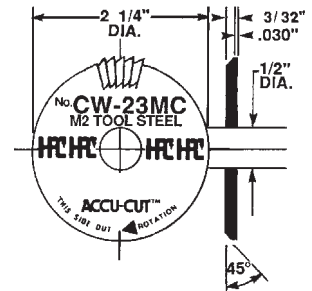

Tool steel cutter with teeth on both sides is ideal for finishing cut. Standard replacement cutter for 9160MC and 9180MC.

Part No.
HPC CW-23MC*

*NOTE: Not recommended for use with 9120RM machines due to their greater RPM speeds which will cause excessive wear on cutters.

Speedex Double Angle Cutters

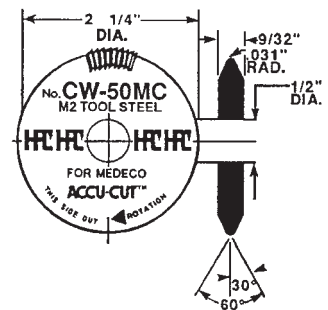

Replacement cutter for CW-51MC Conversion Kit.

Part No.
HPC CW-50MC

Double Angle Conversion Kit

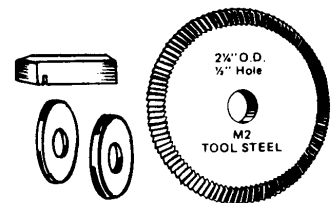

With this kit you are able to cut from depth keys or duplicate. M2 Tool Steel cutter steel, brass or nickel silver.

- Fits the following — all HPC Speedex® Series; Taylor KD-1, 2 etc.; Dominion 145, 146; Iico 2584, 2585; Keil 4, 4 1/2.
- Replaces the following single angle cutters — 23RE, 26, CU-5, CU-1, 23MC & 34MC.
- Set includes CW-50MC cutter, tracer, washers and complete instructions.

Part No.
HPC CW-51MC

OTHER CUTTERS

Standard Steel Cutter

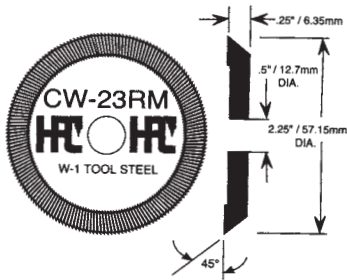

Standard grade W1 tool steel cutter. Standard replacement cutter for 9120RM

Part No.
HPC CW-23RM

ACCESSORIES

Replacement Tip Stop

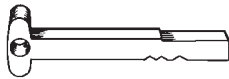

Standard replacement tip stop for the 1200CMB, 1200CM, 1200MAX, 3333 and 6666 key machines.

Part No.
HPC CM-1054MA

Horseshoe Tip Stop

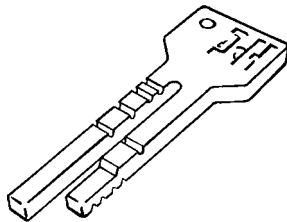

For use with 7 pin Best and 10 cut Ford on 1200 Series machines.

Part No.
HPC CM-1054R

Medeco® Jaw

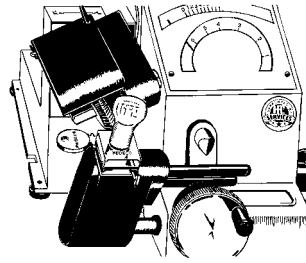

With this Medeco® Jaw you are able to cut Medeco Level 1 commercial keys. This jaw is for use with the 1200CM Series Code Machines and CodeMax™.

Part No.
HPC MJ-1

With this new jaw set, you are able to cut both Level 1 and 2 commercial (Air & Sky) keys. For use with the 3333 Trace-A-Key® machine, with 4-way jaws. Includes two sets of top and bottom jaws.

Part No.
HPC MJ-4

Softie™ Brush

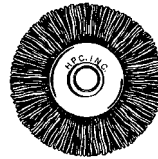

The only key machine brush made of Tylon-X. The carbide-impregnated brush deburrs faster, more smoothly and lasts six times longer than wire. No more flying wire strands and brush flaring.

Part No.
HPC TYX-3

Ford Double Sided Block

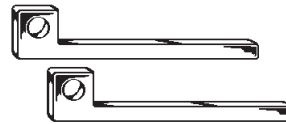

This set consists of two blocks for holding Ford double-sided keys when duplicating.

Part No.
HPC FB-1

Extra Storage Panel

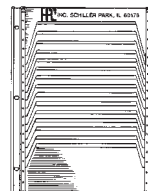

For use with the the 1200 Series. 40 card capacity.

Part No.
HPC CARD-BP

Thrust Bearing Washer Set



Two ball bearing units & four hardened steel washers for key machine wing nut studs.

Part No.
HPC BBW-2

Replacement Wing Nut



This sturdy blue wing nut is virtually indestructible! Fits all 1200 Series, Speedex® Series and Trace-A-Key® Series.

Part No.: HPC SNK-3

HPC SOFTWARE
CodeSource Plus®
The Ultimate Code Retrieval Program

HPC CSCD

HPC's Code Source® is the most comprehensive, user friendly code retrieval program on the market today! It has a database of millions and millions of codes that can be accessed quickly and easily.

CodeSource® makes looking up a code completely effortless and allows you to search

for a code in a variety of ways: by code number, Blitz™, Switch Blitz™ or Punch™ code card number, manufacturer name, key blank number, or by DSD number.

CodeSource® allows you to search by bitting or even partial bitting. It also allows you to print Blitz, Switch Blitz, punch and HKD cards.

The Code Specification window displays the appropriate, Blitz™, Switch Blitz™ and Punch™ code card numbers, CodeMax®, and Blue SHARK® DSD numbers, complete micrometer measurements in inches or millimeters, multiple key blank choices, cutter and punch numbers, proper jaw, graphic of keyway, and all pertinent information about the specific code series. From this screen you may download codes directly to your CodeMax® or BlueSHARK® or print out the screen. Clicking on the "Notes" button displays important information on your selected code and the code series, as well as providing you with space for your own notes. Many other valuable features.

MasterKing™ — Builds Superior MasterKey Systems

HPC MKCD

MasterKing™ will guide you through the development of simple or complex master key systems step by step. You can set up systems very quickly using defaults and factory specifications, or adjust and fine tune almost every aspect of your system to tailor it to your needs.

MasterKing™ creates superior master keying systems faster than ever before. Enter some basic information and MasterKing™ will generate your systems quickly and easily. MasterKing™ eliminates transposed or repeated numbers, as well as uncuttable keys. Manually writing master key systems can be very time consuming and error prone. Use MasterKing™ to produce accurate systems in minutes instead of days.

Features:

- Contains a Database of over 175 lock types from more than 50 manufactures
- Able to Generate 1 to 5 Levels in List Format
- Download System to CodeMax® or Blue SHARK™ Machines
- Allows manipulation of the Key Bitting Array
- Supports Cross-Keying
- Computes Driver & Control Pins in IC Core Systems
- Supports Total Position Progression and Rotating Constants
- Powerful Database feature allows you to export your system in Text, RPT, Dif, ODBC, Tab or Comma Separated, Excel, Lotus or Word Format

KeyTrail™ — For Complete Management of Keys, Personnel, and Locations

HPC KTCD
Features:

- Allows for the complete management of keys, the doors they open, and the people that hold them, all from one screen
- KeyTrail utilizes "drag & drop" technology to move one item to another. For example, to assign a key to an employee, just click on the key and drag it to the employee
- Simple to use. Easy to understand icons, drop down menus, keyboard shortcuts, as well as a comprehensive Help file
- Has a very flexible security feature — the system administrator can set up an unlimited number of security profiles for other people who will be managing the system. Plus KeyTrail™ provides audit trails that track all transactions
- Generates optional work orders to track cylinder installation and key duplication
- Supports IC systems and can interface with MasterKing™, CodeMax® and Blue SHARK™ to make a key producing/tracking package
- Information can be imported or exported in either tab-delimited or comma-delimited format
- Can be installed on an individual PC or on a network server
- Knowledgeable and friendly technical support available at factory

KeyChoice™ — Comprehensive Key Blank Cross-Reference

HPC KCCD

KeyChoice is a database of thousands of key blanks that allows you to sort, search, add, and update information with point and click simplicity. You can sort and search by original and substitute key blank numbers, as well as by description, or by your hook numbers.

You can also sort and search by CodeMax® or Blue SHARK™ DSD number or 1200 CMB and Punch code card numbers. At the top of the screen, a graphic of your selected keyway is displayed, assuring you of proper blank selection. This easy to use program comes with on-screen help and timely updates.

Features:

- Easy-To-Read Columnar Format
- References the Most Popular Key Blank Manufacturers
- Able to Search by Key Blank Number, Code Card Number, DSD Number, Description & Hook Number
- Able to Add, Edit, or Delete Keys and Hook Numbers
- Displays Description of Key Blank Application
- Displays 1200CMB, 1200PCH and 1200CMSB Code Card No.s
- Displays DSD Number
- Displays Graphic of Actual Keyway
- Allows Column Order to be Rearranged for a Customized Screen layout
- Allows Printing of Entire Key Blank Cross-Reference Chart or Selected Key Blanks
- Immediate Access to On-Screen Help Function
- Able to Interface with HPC's CodeSource™

BOOKS

Car Opening Authority™



HPC COA-22

The most comprehensive vehicle entry manual available!

A multifaceted, user-friendly manual that serves not only as a reference book but also as an educational aide and opening index. Details every known type of professional vehicle entry technique, with over 650 models, lists virtually every production vehicle by year, indexes one or more opening techniques for each vehicle, and recommends one or more tools to use to safely open a locked vehicle. This manual is fully illustrated and easily updatable. Once you learn how to perform each of the opening techniques, you can use the index to open virtually any car on the road!

Also available in CD format

Part No.

HPC COA CD F/O

Learning Center Library Reference Collection

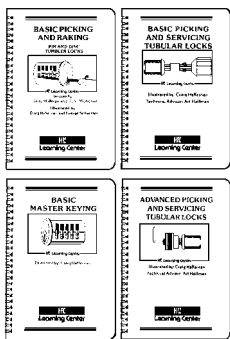

A series of technical manuals designed with the security professional in mind. Clearly written; meticulously detailed exploded view drawings.

Basic Picking

Describes in detail the theories and techniques for picking standard pin and wafer tumbler locks. All the necessary tools (such as picks and tension wrenches) are listed and fully illustrated for convenient cross-reference.

Part No.

HPC LC-1

Also available on Factory Order

Part No.	Description
HPC LC-2	-----Basic Tubular Picking
HPC LC-4	-----The Ford 10 Wafer
HPC LC-5	-----Basic Impressioning
HPC LC-7	-----Advanced Tubular Picking
HPC LC-8	-----Basic Electricity For Locksmiths
HPC LC-15	-----Pass Key/Vats

Safe & Vault Manual

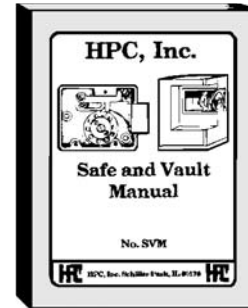

HPC SVM

- Hand Changing
- Key Changing
- Drilling Locations
- Lock Servicing
- Internal Drawings
- Time Lock Operation

The Safe and Vault Manual is generally recognized as the “Safe Man’s Bible.” This book contains valuable information covering a wide variety of safe lock topics. It contains over 250 illustrations, 1000 factory try-out combinations and a section on original factory methods of safe and vault combination changing.

CAR OPENERS

Pro Killer Kit

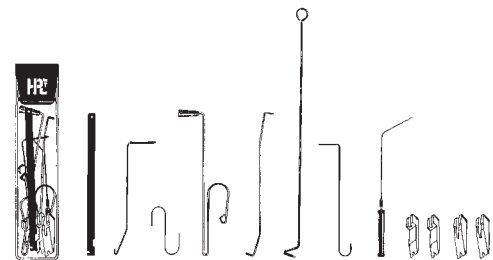

HPC AKK-66

The Pro Killer Kit includes all the same tools as the AKK-55, plus the Safari Joe™ (CO-62) for horizontal offset linkage, the Collapsible Opener (CO-6) for through the car, Mercedes Benz Opener (CO-21) for vacuum locks, Flex-A-Light (FAL-15) , and 3/4" auto wedges (AW-34). The Pro Killer Kit comes complete in a clear-view plastic case.

Items on this page are subject to restricted sales
CAR OPENERS
Slim Jim™



HPC CO-10

HPC's Slim Jim™ has been the entry tool by which all others have been judged since its introduction in 1967. Although automobiles have changed considerably in recent years, the large number of applicable cars on the road allows the Slim Jim™ to remain a necessity for all auto lock specialists.

Super Jim™

HPC CO-11

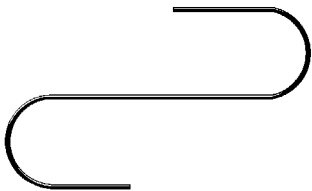
The Super Jim™ is a wider version of the Slim Jim™ and on some models may be faster.

Jim Dandy™

HPC CO-22

The Jim Dandy™ is an extremely versatile under button opener. It is designed for GM models and is also great on most Japanese cars and trucks.

Super Killer™

HPC CO-70



The Super Killer™ with its extra length and great strength can be used to open a wide variety of

vehicles. By inserting the tool at an angle, it can get under the deepest windows. The strength of the Super Killer™ is such that it can be used to push, pull or lift lock indicators, even those operated by power door locks. The CO-70 can open many new vehicles, especially GM's.

CLUTCH CAR OPENERS

HPC's Clutch Car Openers are unlike any others on the market. When the handles of the tool are separated, the hook at the end of the tool is pulled inward, causing the tool to grip or bind the linkage rod. This new type of car entry tool will help to simplify the "in-the-door" method of vehicle entry. Two different styles are available: The Horizontal Clutch™ for vehicles with horizontal linkage and the Vertical Clutch™ for vehicles with vertical linkage.

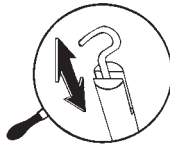
Horizontal Clutch™

HPC CO-75

Vertical Clutch™

HPC CO-76

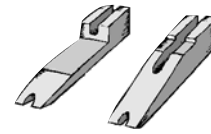
CAR OPENERS
Ultimate Auto Wedges

The ultimate auto wedges are designed for smooth safe insertion without risk of dropping into the door

cavity. The edge of the wedges taper, to avoid it popping back out of the door. The special "illumination hole" allows nearly any flex light to pass through and focus directly on the desired location, without being held in your hand.

Part No.
HPC AW-38 (3/8")
HPC AW-34 (3/4")

Air Wedge™

HPC's new Air Wedge slides between the vehicle door and the weather stripping on the door frame. Then the pump is squeezed, inflating the Air Wedge and separating the vehicle door from the frame. This provides more than ample room to insert a car opening tool. Made of sturdy vinyl and equipped with a release valve.

Part No. **Dimensions**
HPC AW-99 -----6.25" x 5.75"

Universal Air Wedge®



What makes the Universal Air Wedge® special is its increased width, giving you a larger gripping area for inserting the wedge into the top corner of tighter fitting doors. Both are equipped with a release valve.

Part No. **Dimensions**
HPC AW-100 -----11" x 5.125"

Items on this page are subject to restricted sales

PICK SETS

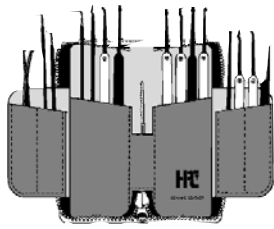
Deluxe Pick Set



HPC NDPK

- Shirt Pocket Size, 2⁵/₈ × 6³/₈" Closed
 - Genuine Leather Case with Full Zipper
 - 10 Picks, 4 Tension Tools, and 2 Extractors
- Perfect for the beginning locksmith. Each pick is made of a hardened spring steel, tempered to the correct degree of hardness.

Superior Pick Set

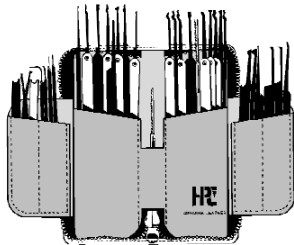

HPC NDPK-32

- Shirt Pocket Size, 2⁵/₈ × 6³/₈" Closed
 - Genuine Leather Case with Full Zipper
 - 22 Picks, 7 Tension Tools, and 3 Extractors
 - Hardened Spring Steel Components
- The Superior Pick Set is perfect for the discerning locksmith. It provides a nice selection of picks for a variety of uses.

Pick Set Case

Case only for NDPK or NDPK-32

Part No.
HPC NDPK Case

Professional Pick Set

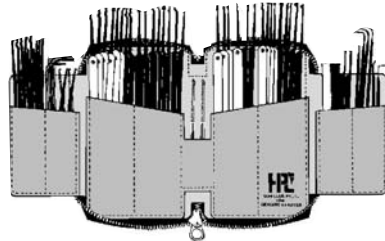

HPC NDPK-60

- Jacket Pocket Size, 4 × 6¹/₂" Closed
 - Genuine Leather Case with Full Zipper
 - 40 Picks, 14 Tension Tools, and 6 Extractors
 - Hardened Spring Steel Components
- The Professional Pick Set contains a generous assortment of the most popular picks, tension wrenches, key extractors, and feelers.

Flip-It™

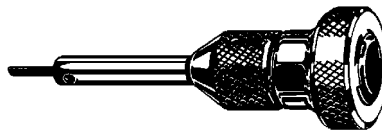

HPC FIT-2

When picking a lock in the wrong direction (intentionally or in error), the Flip-It™ will flip the cylinder plug past the upper pins and save you the job of repicking. Comes with 2 exclusive features. The two pin Quick Lock/Release feature allows for easy release of the rotating action. The sure stop feature prevents over-winding in either direction.

Paramount Pick Set

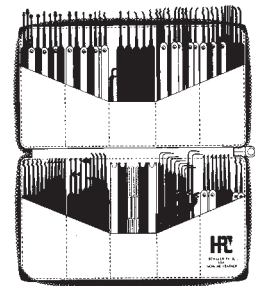

HPC NDPK-100

- Tool Box Size, 6 × 9" Closed
- Genuine Leather Case with Full Zipper
- 72 Picks, 19 Tension Tools, and 9 Extractors
- Hardened Spring Steel Components

This set is for the discriminating locksmith who desires an extensive assortment of lock picking tools, so that replacement will be unnecessary for some time. Contains a wide choice of full, half and three quarter rakes and diamond tips; half, single and double ball picks; light, medium and heavy weight tension wrenches; hook and saw type key extractors and a set of warded padlock pick keys.

I.D. Badge Pick Set

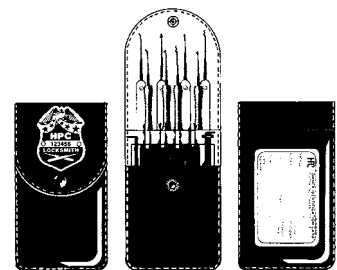

HPC PIP-23

- Shirt Pocket Size, 3 × 5¹/₂" Closed
- Genuine Leather Case with Full Zipper
- 12 Picks, 2 Tension Tools, and 4 Extractors
- Hardened Spring Steel and Stainless Steel Components

The I.D. Badge Pick Set is a handy way to carry a lock picking set and a means of identification at the same time. On the back of the case there is a pocket containing an identification card with space for a photo or thumbprint of the owner. The set contains 4 pick grip handled picks and extractors, 4 stainless steel handled picks, 2 tension tools and a set of 4 double sided picks for disc tumbler locks.

PICK SETS

Novice Pick Set



HPC PIP-13

7 picks, 3 tension wrenches and a broken key extractor. The tools are made of hardened spring steel and come with a top grain leather case.

Tyro Pick Set



HPC PIP-15

6 picks, 2 tension wrenches and a broken key extractor. The tools are made of hardened spring steel and come with a top grain leather case.

Computer Generated Pick Set



HPC COMP-1

Nine computer designed picks and two tension tools, made of hardened stainless and spring steel components.

2000 Series Extractor Set



HPC ES-2000

The ultimate in broken key and pick removal. The tools are designed to slide next to broken keys along the side mill and ride along the bottom pins to hook into a cut in the key. Made of high grade stainless steel and can be bent to reach around many obstacles.

Disc Tumbler Lock Picks

Double-Sided

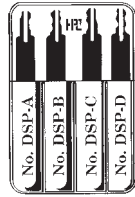

HPC DSP-1

This set of four picks can be used on the most popular double-sided, disc tumbler, showcase, cam and padlocks.

Padlock Shim Picks

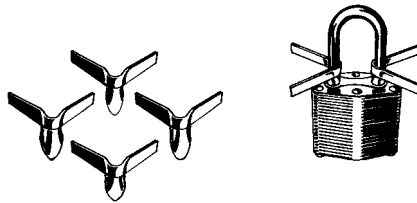

HPC PSA-20

This 20 piece Padlock Shim Pick Set is a fantastic alternative to picking, and in many situations is the only way to open a padlock in seconds. The shim picks' unique design makes them amazingly successful. The assortment contains five of each of the most common shackle diameters which enables it to open a broad spectrum of locks.

Jackknife Pick Set

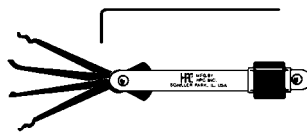

HPC JKP-5

A complete compact pick set to use on pin and disc tumbler locks. Two rakes, one diamond, one hook and one tension wrench. It folds up and fits in your pocket.



HPC JPO-1

Optional leather case measures 4 x 3/4".

Dental Style Pick Set



HPC NDPX (set)

The Dental Pick Set contains precision instruments that are hand made from the finest quality stainless steel. They have the accurate balance and feel that a locksmith needs while doing precise work. Picks are 6 3/4" long and comes in an aluminum tube. A tension wrench is also included in the set

PICK SETS

Vise Head Key Extractor Set

Changeable

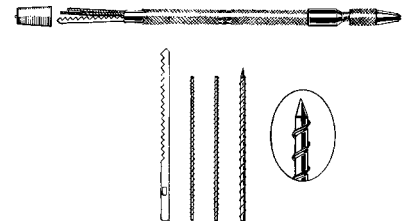

This broken key extractor set includes 4 changeable blades stored inside a hollow handle; 1 saw type extractor blade, 2 round extractors (.040" diameter), and 1 round extractor (.050" diameter). Replacement blades are available in packs of 10.

Part No.	Description
HPC EZ-6	Vise Head Key Extractor Set
HPC EZ-7A	Ten Saw Type Extractor Blades
HPC EZ-7B	Ten Round Type Extractors, .040" dia.
HPC EZ-7C	Ten Round Type Extractors, .050" dia.
HPC EZ-7D	Ten Assorted: four of 7A, four of 7B, two of 7C

PICKS SETS

Replacement Pick Gun Needles



These pick blades are made of hardened spring steel and fit the HPG-10, EPG-1 and VIPS-14.

Part No.	Description
HPC P-2	Straight Blade .035"
HPC P-3	Curved Blade .035"

Warded Padlock Pick Set

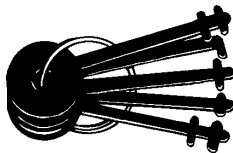

HPC PKS

Efficiently opens warded padlocks. Avoid costly destruction of padlocks with this convenient set.

Pick Grip Handle



HPC PICK GRIP

Sold in packs of 10 only.

This soft foam pick grip is for picks with or without metal handles. Unique design grips tools without any adhesive. It is 3/16" round, and the inside diameter expands to also hold: files, wire cutters, pin tweezers, car openers, etc. Provides maximum pulling strength for key extractors.

Electropick™



HPC EPG-1

HPC's Electropick™ is the original cordless rechargeable electric pick gun. Allows for the locksmith to duplicate his or her exact raking motion at many times per second. The gun rakes open pin and disc tumbler cylinders using a rapid up and down striking movement, which causes the top and bottom pins to separate, meeting the shear line. The up and down motion is adjustable by thumb-screw with a locking nut controlling the action after the range of motion is set. Comes complete with a charger (for bench or wall mount), 3 raking tools and 2 tension tools.

Stainless Steel Pen Pick Set



HPC VIPS-14

The Stainless Steel Pen Pick Set (VIPS-14) comes complete with fourteen stainless steel picks that can be stored in the aluminum body. This is a handy way to keep a pick set with you in a discreet manner. Pick blades also fit the EPG-1.

PICKS

Standard 7 Pin Tubular Pick



HPC TLP-C

The Standard 7 Pin Tubular Pick is the direct descendant of the first tubular lock pick manufactured by HPC. Although its design has been slightly refined during its more than 30 years in existence, it can still open most locks in seconds and is the most trusted tool of its kind. It features an aluminum handle, stainless steel barrel and spring steel feelers. Comes in a genuine leather case with the TKPD-1 decoder.

Model B Tubular Pick



HPC TLP-CMOD-B

The Model B is an upgraded model of the TLP-C. Rubber bands have been eliminated by the employment of a collar and o-ring. This design permits infinitely variable tension against the feelers. The Model B comes in a genuine leather case, with the TKPD-1 decoder.

Peanut Tubular Pick



HPC TLP-PEANUT

The Peanut is HPC's most economical tubular lock pick, yet it offers numerous features making it a highly effective tool. The barrel is composed of Delrin which enables the wall thickness to be minimal without the brittle tendency of most metals. Also, a Silicone O-ring is utilized to maintain steady feeler tension. A spring-loaded center pin enables locks to virtually pick themselves. The TKPD-1 decoder is included.

PICKS

Prefix "HPC" when ordering.

Ball Picks

- BPX-5 (.022")
- BPX-51 (.022")
- BPX-4 (.022") F/O
- BPX-41 (.022")
- BPX-6 (.022") F/O
- BPX-61 (.022") F/O
- BPX-2 (.022") F/O
- BPX-21 (.022") F/O
- BPX-1 (.022") F/O
- BPX-11 (.022") F/O
- BPX-3 (.022") F/O
- BPX-31 (.022") F/O

Diamond Picks

- LPX-10 (.022")
- HLPX-10 (.028")
- P-10 (.022") F/O
- CPX-10 (.022")

Hook Picks

- P-11 (.022) F/O
- CPX-12 (.022)
- LPX-12 (.022)
- HLPX-12 (.028)
- PX-31 (.022) F/O
- HPX 31 (.028)

Rake Picks

- LPX-11 (.022)
- HLPX-11 (.028)
- LPX-15 (.022)
- LPX-16 (.022)

- P-12 (.022)
- P-8 (.022) F/O
- P-9 (.022) F/O
- CPX-11 (.022)
- P-13 (.022)
- P-31 (.022) F/O

Misc. Extractors:

- EZ-1 (.022)
- EZ-5 (.040)
- EZ-2 (.022)
- EZ-3 (.022)

"2000 Series" Stainless Steel Picks

- SSP-10 F/O
- SSP-11
- SSP-12
- SSP-13
- SSP-14
- SSP-20
- SSP-30 F/O
- SSP-31 F/O
- SSP-40 F/O

"2000 Series" Stainless Steel Extractors

- SSX-10
- SSX-11
- SSX-20
- SSX-21

Items on this page are subject to restricted sales

TENSION TOOLS

Prefix "HPC" to part number when ordering.

Light Tension

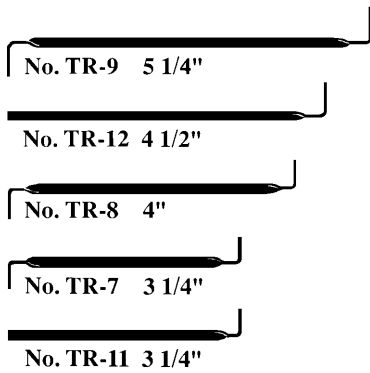

Medium Tension

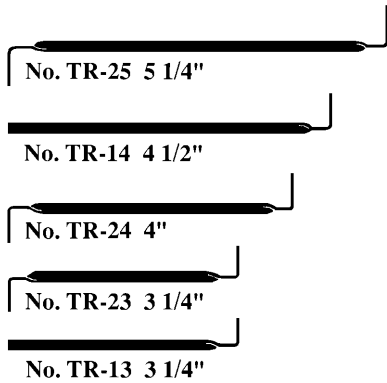

Rigid Tension

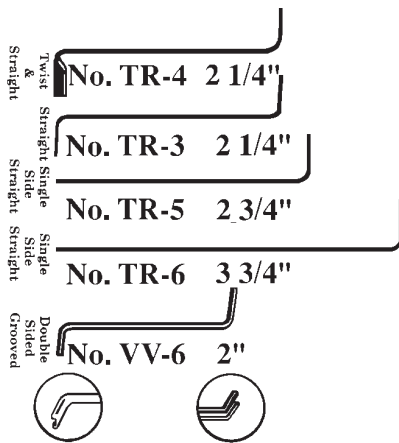

For Tulip Shaped Knobs

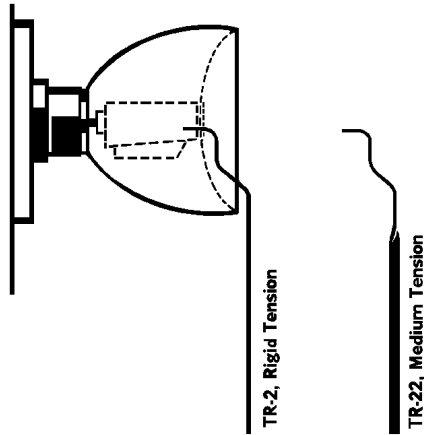

Part No.	Description
HPC TR-2	Rigid Tension
HPC TR-22	Medium Tension

Tension Wrench



Part No.	Description
HPC STW-3	Variable Tension

Double Sided Tension Wrench

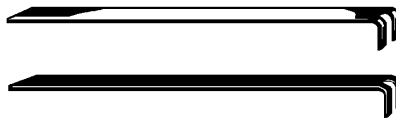

Part No.	Description
HPC TEN-9	Heavy Tension
HPC TEN-7	Light Tension

Torque & Tension Tools

Incorrect tension is one of the most common causes of picking failure. Use of these tools provides an easy method to apply the correct amount of tension every time.

All Torque and Tension tools provide a large opening diameter allowing unrestricted entry of picking tools. The dual prongs assure even torque, always keeping the plug in proper alignment. All units are feather weight and pocket sized with easy to hold knurled collars.

HPC TNT-1, 2, and 3 all feature easy to read tension indicator and dual coil spring construction. HPC TNT-15 is a simplified tension device without spring-controlled tension.



Chrysler and Ford Double Sided, Toyota, VW, Mercedes, etc.

Part No.	Color
HPC TNT-1	Red Center



Regular House Cylinders, etc.

Part No.	Color
HPC TNT-2	White Center



American Motors, American Padlock, Chicago Double Sided, Foreign Autos, etc.

Part No.	Color
HPC TNT-3	Blue Center

TOOLS



Concave knobs, etc.

Part No. HPC TNT-4 **Color** Silver Center

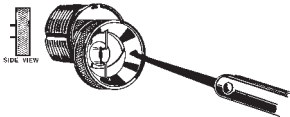

Regular House Cylinders, etc.

Part No. HPC TNT-15

Stamp Aligner™

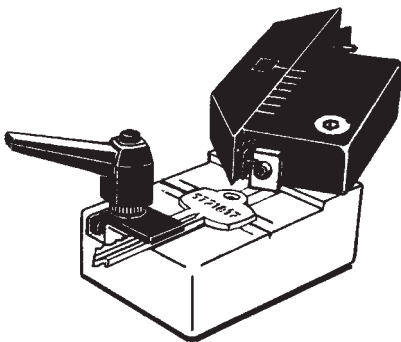

Stamps not included.

The Stamp Aligner™ solves the problems locksmiths have always had while stamping numbers on keys. It holds the stamps so that figures may be stamped on keys in a straight line with even spacing between characters. When the stamps are all struck with the same force, the result is a key that looks like it was factory stamped.

Part No. HPC SA-7 **Description** 1/4" square hole fits 1/8" & 3/32" character stamps

Hand Cut Die Stamp Sets

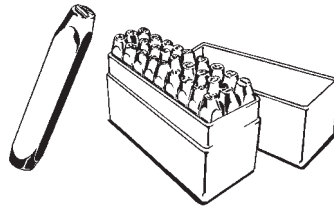

Stamps can be used alone or with Stamp Aligner™.

- Tempered Head Prevents Mushrooming
- Extra Tough Shank Prevents Bending
- Hand Ground Taper Makes Locating Easier
- Specially Hardened Character End Prevents Chipping
- Index on Thumb Side Prevents Stamping Upside-Down
- Sharp Chisel Edge Character Face Assures Clear Impressions
- Chrome Plated

Figure Sets:

Part No.	Description
HPC HCF 3/32	3/32" character/w 1/4" shank
HPC HCF 1/8	1/8" character/w 1/4" shank
HPC HCF 3/32	3/32" character/w 1/4" shank
HPC HCF 1/8	1/8" character/w 1/4" shank

Special Locksmith Stamps

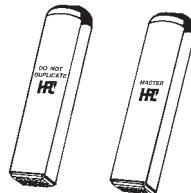

Permanently mark a Master or Restricted key with HPC's special locksmith stamps. Let other locksmiths & key duplicators know it is a special purpose key and is part of a restricted system. The stamps are made of heavy duty steel stock, 3/8 x 5/8", hardened and flash-chromed for years of trouble free service.

Part No.	Description
HPC LDND	"DO NOT DUPLICATE"
HPC LMS	"MASTER"

Key File Set

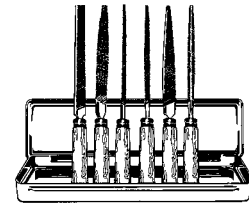

HPC KFS-6

Includes six 4" files with wooden handles.

- Swiss Pattern Round — tapered
- Swiss Pattern — warding tapered
- Swiss Pattern — rectangular straight
- Swiss Pattern — 3 sq. tapered
- Swiss Pattern Square — tapered
- Swiss Pattern — half round tapered

Router-Drill

Saws, Drills, Routs, Files

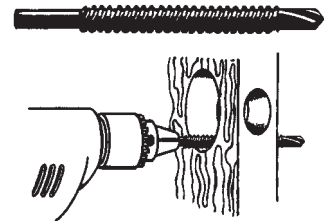

HPC RD-1

The Router-Drill fits any electric drill or drill press. It cuts its own starting hole in any shape or direction that the tool is moved. It has sharp milled flutes for fast cutting action that will not clog! Ideal for enlarging holes and making scrolls. It cuts wood, plastics, non-ferrous metals and is made of hardened steel for a long life.

Ignition Drill Template for Ford

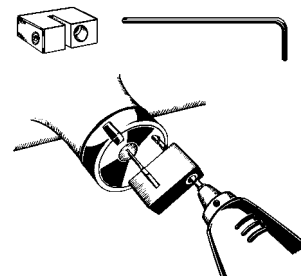

HPC ITF-14

This template allows swift, precise removal of the side-bar so that replacement can be done almost immediately. Accuracy is ensured by the use of a key blank (not included).

TOOLS

Straight Yoke Micrometer

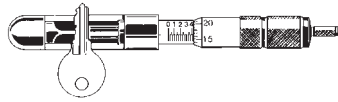

HPC SKM-1

This straight yoke key micrometer has ratchet thimble to assure proper tightening for an accurate reading in thousands of an inch. It has a satin chrome body and yoke, and also comes in a leather case.

Pocket Size Decoder Kit

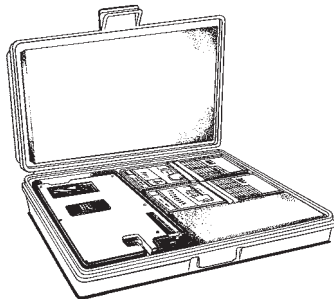

HPC HKD-75 (complete unit)

This handy, pocket sized decoder kit determines the original factory depths of most popular domestic pin and disc tumbler cylinders and automotive keys. It is ideally suited for giving the correct bottom pin size when re-keying new or worn cylinders. Simply insert the correct information card into the top slot of the decoder. Lowering the depth pin into each cut, from bow to tip, will indicate the correct depths in the window at the top. Each of the 2" x 4" information cards also lists the correct factory depths and space specifications. It comes complete with handy plastic carrying case, 3 shims and 111 information cards.

Lever Handle Remover



HPC's Lever Lock Handle remover is designed to quickly remove locked lever handles for servicing. It is ideal when picking the lock is not an option. You simply place the tool's specially designed hub over the lever, and using a simple procedure of manipulating a few bolts and screws you are able to remove the handle, open the door, and service the lock. Simple to use with amazing results!

Part No.
HPC LHR-100

Replacement Screws:

Part No.	Description
HPC LHR-LSCREW	-Lrg Pin Depression Screw
HPC LHR-SSCREW	-5m. Pin Depression Screw
HPC LHR-HBOLT	---Holding Bolt

Cylinder Drill Jigs

Occasionally, it is found that a mortise or rim cylinder is impossible to pick. Even the best lock picker may be foiled by a broken cylinder spring, corroded pins, etc. In these cases drilling is the answer. The CDJ-1 and CDJ-2 drill jigs are designed for such situations. These jigs will assure perfect alignment on the shear line for a drill bit. (Drill bits are not included.)

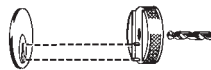

HPC CDJ-1

Cylinder Drill Jig and Drill Bit for Flat Face Cylinder

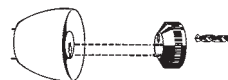

HPC CDJ-2

Cylinder Drill Jig and Drill Bit for Recessed Tulip Design Types

Removable Core Drill Jig

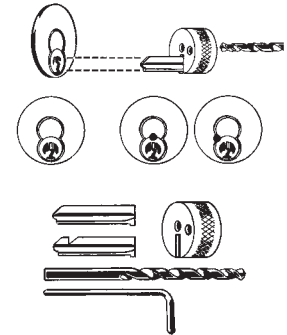

HPC CDJ-3

You will be able to drill the cylinder in just the right location to enable you to either drill out the shear-line or drill out the retaining pin to remove and save the entire core (which can then be disassembled to determine the bitting of the control key). Comes with drill bit, 2 key blades and an Allen wrench.

Tubular Lock Drills

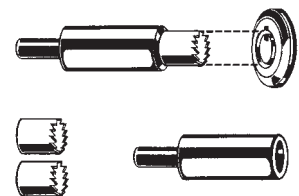

If picking is not possible, lock-outs of tubular key locks can still be serviced. These hole saws destroy the pins at the shear line. Hole saws are available for standard and oversize keyways. Saws will fit any 1/4" electric drill. Saw life is approximately 3 openings. Not for use on locks with hardened pins or ball bearings in the keyway.

Part No.	Description
HPC AG-1	-----Standard Size Tool + Extra Saw (for .375" dia.)
HPC G-1	-----Replacement Saw for AG-1

TOOLS

Mortise Cylinder Lock Tap & Die Set

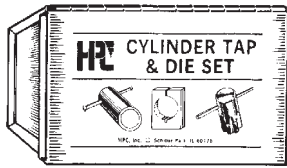

Bothered by stripped mortise cylinders and lock cases? How many times has a customer come into your shop with a stripped mortise cylinder, because he unscrewed it without loosening the retaining screw or fork? This kit offers the solution to this problem as well as the more important task of rethreading cylinders and cases that are no longer manufactured and must be repaired.

Part No.	Description
HPC CLD-6	Cylinder Re-threading Die & Holding Fixture
HPC CLT-4	Lock Case Re-tapping Tap
HPC CLTD-5	Complete Tap and Die Kit w/ Cylinder Holding Fixture & Metal Box

Metal Punch and Die Sets

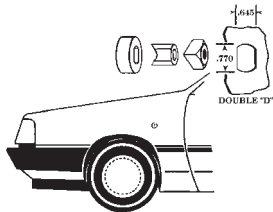

HPC HDPS-4

This set punches a double "D" hole. A necessary aid to the locksmith for installing vending machine and cam type locks on metal cabinets, sheet metal lockers, filing cabinets and cash boxes made of single wall, sheet metal of 18 gauge or lighter. For use on steel only.

GM Tumbler Decoder Gauges

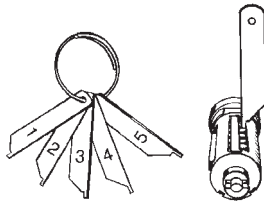

HPC GMTD-5

This inexpensive set of gauges eliminates the guess work when reading the tumblers on 6-cut single-sided GM keys. No need to take apart the lock or waste key blanks by "eye-balling" the depths. Simply press inward on the side bar and rake the tumblers, until the side bar moves inward to the unlocked position. Then place gauge pin over each wafer until the shoulder stop butts against the top of the plug.

Flat, Round Spring Steel



HPC FRS-4

This spring steel assortment contains different sizes of the most popular flat and round blue steel. The assortment is cut into convenient 9" lengths and is packaged in a see-through round plastic container. 1/2 lb., over 50 pieces.

Impression File Safety Case



- Protects File, Pocket, and Wearer

Part No.	Description
HPC IFH-2	Case + HPC 2 Cut Impression File (coarse)
HPC IFH-4	Case + HPC 4 Cut Impression File (fine)

Lockplate Compression Kit

Steering Column

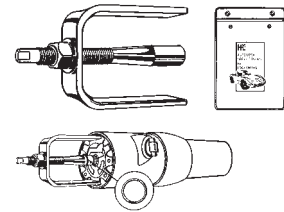

HPC SWLPC-1

This is a complete kit for new style air bag columns, as well as older models. It includes both standard and metric threaded shafts and set screws, along with a longer, narrower U-bracket, for air bag and telescoping columns.

The kit includes the metric internally threaded shaft and set screws that are required for 1978 to present on General Motors. It also comes with a handy 9 x 12" vinyl pouch to carry this tool set plus many of your other automotive service devices.

Lockplate Compressor

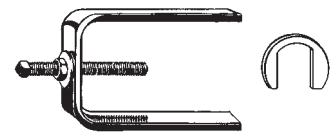

HPC SWLPC-2

A specially designed lockplate compressor for tilt telescopic columns used on pre-1978 General Motors. Assures easier access to ignition lock retainer after steering wheel is removed.

TOOLS

Clip Removal Tools

For Door Handle & Window Cranks



HPC AST-3

Easily removes the hard to reach retaining clips without damage. These clips can be found on GM, Ford, Chrysler and various other vehicles.

For Door Trim Pads



HPC AST-4

Gaining access to the automobile door lock cylinder requires removal of the door trim pads, as well as the regulator cranks. Removing the trim pads without tearing out the nylon retainer clips has always been difficult. The tapered end of this heavy duty lever type tool enters between the door and trim pad, and gently removes the pad. This greatly reduces the possibility of tearing or damaging the pad and clips.

Auto Door Panel



HPC AST-5

The offset design combined with a longer handle allows you to reach clips toward the center of the panel. A must for the locksmith specializing in automotive service. Saves time and work on both foreign and domestic models.

Clean Grip Impressioning Tool



HPC's new Clean Grip Impressioning Tool holds onto the center of the key blank, not by the face. This eliminates the possibility of scratching the face of the key blank, while providing firm hold. It has a unique locking mechanism with a retaining pin that ensures a tight grip in the key blank. The cushioned handle is comfortable and easy to hold. This tool will hold a variety of key blanks and has been designed to be simple, quick, and dependable. With the key blank locked in place, you are ready to impression with confidence.

Part No.
HPC CGIT-10

Auto Lock Cap Pliers

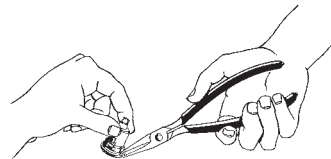

HPC ALCP-10

Remove auto lock face caps easily in seconds. The specially machined tips grip like the jaws of a bulldog — and won't let go! It quickly removes either the factory lock cap using the rolled crimp, or the "Tab Style" replacement caps.

Snap Ring Pliers

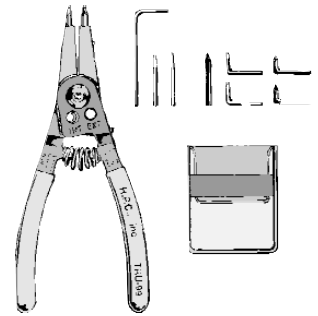

Convertible snap ring pliers quickly and easily convert from "external" to "internal" use. These pliers also feature an adjustable stop that limits the jaw opening for both external and internal operation. They can be used on internal rings in sizes of 1/4" to 1"; and on external rings in sizes of 1/8" to 1". Comes with five pairs of interchangeable tips.

Part No. **Description**
HPC TRU-99 -----Complete Set
HPC TRU-T99-----Tips only (F/O)

Gateway™ Tools Set

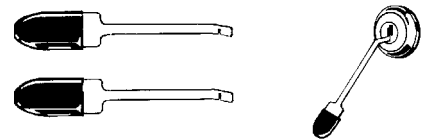

HPC GTO (Two piece Set)

This revolutionary tool acts as a third hand to hold aside the dust cover on auto door locks, exposing the entire keyway, so that picking or extracting broken keys can be done more quickly and easily. The universal slot size covers all of the major U.S. domestic manufacturers (GM, Ford and Chrysler), as well as many imports (BMW, Volkswagen, Toyota and Honda).

TOOLS

Graphite Gun



HPC HGG

Refillable, Leak-Proof & Clog-Proof
Use HPC's Graphite Gun prior to picking or impressing. It loosens tight wafers or pins. Made in the USA with real rubber.

Bulk Graphite



HPC GG-16

High quality finest micro-spray refill graphite. One pound per can.

Truarc Ring Assortment

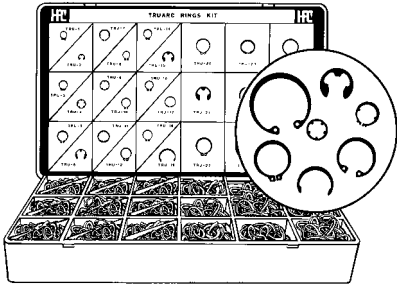

HPC TRU-275 (260 rings total)

This assortment contains 27 different styles of Truarc rings and retainers. They are very helpful for servicing Arrow, Best, Corbin, Dexter, Ilco, Lockwood, National, Schlage and many more. They are made of carbon spring steel and offer long lasting tension or compression for retaining purposes. Replacement rings are available on F/O.

Nose Puller

For Safe Deposit Boxes

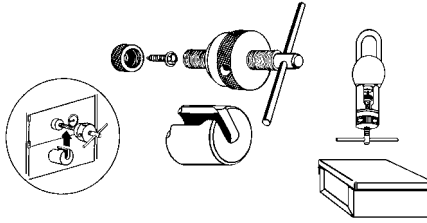

HPC NP-4B

This heavy wrought and bar steel set is expertly machined and finished to effectively pull out a lock core. Simply turn screw into the center of core's keyway to act as an anchor. Then slip the spacer block into place and tighten by turning knurled knob. Continue turning clockwise, slowly and gradually until the entire core is drawn out. Then use the guard key and disengage bolt. If door does not open, then it becomes necessary to use the Door Puller device HPC DP-7B. The Nose Puller set is available separately. However, when ordering the HPC DP-7B Door Puller set, the Nose Puller set HPC NP-4B is included, along with a steel carrying case. The nose Puller can also be used for removing the plug from a padlock.

Replacement Parts for the Nose Puller Set (all are available F/O):

Part No.	Description
HPC NP-4B-1	Screw retainer
HPC NP-4B-2	Standard Hex Head Sheet Metal Screw; 10 per pack
HPC NP-4B-3	Threaded Shaft
HPC NP-4B-4,5	Ball Thrust Bearing & Knurled Knob
HPC NP-4B-6	Handle
HPC NP-4B-7	Spacer Block

Truarc Ring Pliers

Two tools in one!

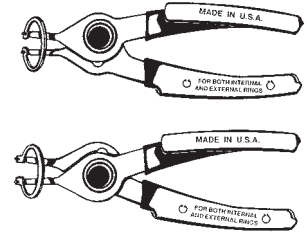

HPC TRU-55

Combination Ring Spreading/Compression Tool. Two pivot centers; dual operation. #1 center is for compressing, #2 is for spreading action. Changeovers are made quickly and easily.

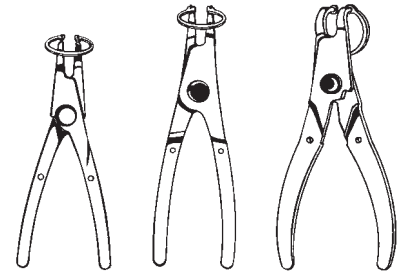

Part No.	Description
HPC TRU-121*	Compressor
HPC TRU-122*	Spreader
HPC TRU-123*	Compressor

* F/O

TOOLS

Door & Nose Puller

For Safe Deposit Boxes

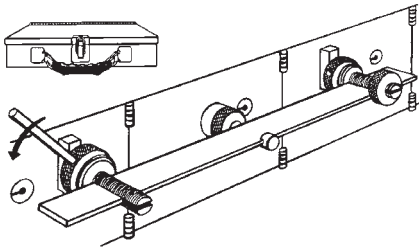

HPC DP-7B
Available on Factory Order

Complete Door Puller Set in position and ready to pull out the safe deposit door. After the lock core has been pulled and use of the guard key has not opened the door, then it is time to apply the Door Puller set. Place the stepped Spacer Block onto the hook unit. The three different diameters steps make it adaptable to three different sizes of plug bores. Place the corrected diameter step into the corresponding bore. Have the hook end set against the inside back wall of the door, then tighten the knurled nut to hold the hook in place. The flat surface on the outside of the hook unit should be in a level position.

The long flat blade is then fitted onto the holding slot, along with the remainder of the Puller unit, as shown above. Position feet away from the centers of adjacent doors, to minimize the possibility of distortion. The knurled nut is then turned until the door is pulled out. HPC DP-7B includes Nose Puller Set HPC NP-4B — all within a carrying case.

Part No.	Description
HPC DP-7B-1	Hooked Anchoring Post
HPC DP-7B-2	Knurled Nut only, to fit Anchor Post & Leg
HPC DP-7B-3	3 Diameter Spacer Block
HPC DP-7B-4	Flat Blade
HPC DP-7B-5	Slotted Leg with Foot
HPC DP-7B-6*	Handle
HPC NP-4B-4,5*	Ball thrust Bearing & Knurled Knob for Thrust Bearing

Safe Drill



Premium quality tungsten tip drill bits designed for multiple use on steel hardened to Rockwell C-40 up to C-64.

Part No.	Description
HPC SHPD-12	8"L; 1/4" dia. tungsten carbide tip

Utility Tags

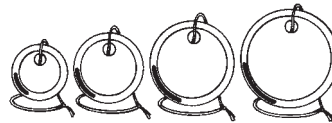

- Personal Property
- Price or Size Tags
- Will-Call Items

For use on heavy or much handled merchandise, where strength and non-mutilating qualities are required. These metal rim utility tags are manufactured from heavy stock with a smooth writing surface. Each tag has an attached string, looped and knotted. Packed 100 per box.

Part No.	Description
HPC ERD-0	1" Utility Tag
HPC ERD-1	1 3/16" Utility Tag
HPC ERD-2	1 1/2" Utility Tag
HPC ERD-3	1 13/16" Utility Tag

Tags for Key Identification

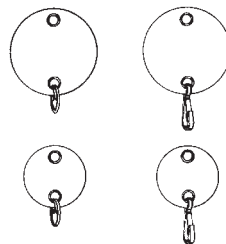

Packed 100 per box.

Part No.	Description
HPC EYR-7	1 3/4" dia. with ring
HPC EYR-5	1 1/4" dia. with ring
HPC EYS-8	1 3/4" dia. with snap
HPC EYS-6	1 1/4" dia. with snap

Plug Followers

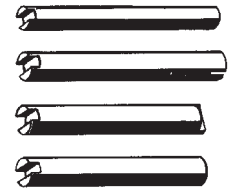

These plug followers will fit virtually all of the rim or mortise cylinders currently in use. They are made of centerless ground bar stock.

Part No.	Description
HPC SUT-0*	.395" dia. Plug Follower
HPC SUT-1	.495" dia. Plug Follower
HPC SUT-3	.500" dia. Plug Follower
HPC SUT-10*	.550" dia. Plug Follower
HPC SUT-47	Set of all four

*F/O

Adjustable Follower

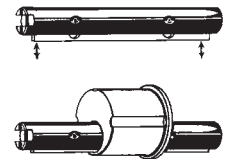

HPC SUT-22

Fits all standard locks .495" to .600" in diameter. Spring loaded; will fit most locks.

Hollow Brass Follower Set

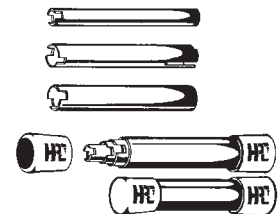

HPC SUT-14

This set contains three popular sizes of medium-hard, hollow brass followers. Each fits into the other and into their case for convenient compactness and protection. This follower kit will also work on the new style Corbin Russwin heavy duty knob lock cylinder unit. The small diameter follower is useful for cabinet locks, peanut size cylinders and the new type pin tumbler letterbox locks.

TOOLS

Vise Held Plug Holder

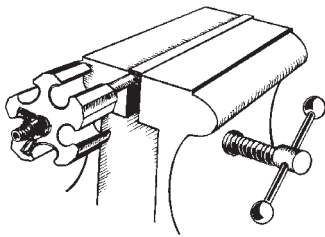

HPC CPH-5

Holder bodies are hardened and have a black oxide finish. Holds the five most popular sizes: .404, .504, .508, .512 and .556.

Adjustable Plug Holder

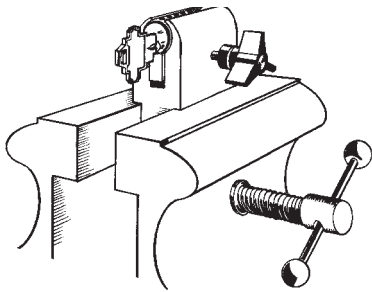

HPC SUT-600

The Adjustable Plug Holder is a universal plug vise. Adjusts its own hole size from .350" to .600" to give a perfect fit on many different cores. The plug vise body and slide are hardened and have a black oxide finish.

Bench Plug Holder

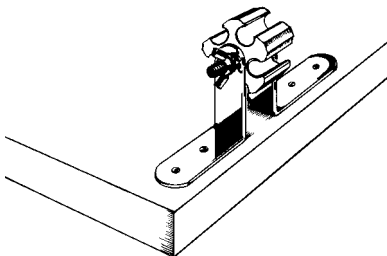

HPC CPH-9

Holds the five most popular sizes: .404, .504, .508, .512 and .556.

Solid Plug Holder

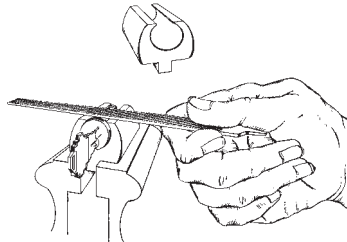

HPC CPH-10 (.510" Hole)

The holder is made of hardened bar stock, which prevents it from being scratched by the file.

Retainer Staking Fixture

For GM Auto Locks

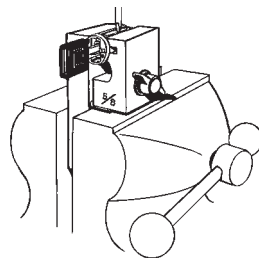

HPC RSF-1

The tumbler retainers on General Motors auto locks must be staked to prevent their popping out and causing unnecessary "lock-outs". This case hardened vise-held fixture, grips the core tightly without distortion while staking the four corners of the retainer with a small chisel-edge punch.

Large Key Rings

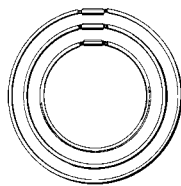

Made of half-hard steel. Threaded fastener, screws either to the left or the right. The 11" ring slips over head easily for carrying around the neck and holds 260 keys.

Part No.	Diameter
HPC LKR-6	6"
HPC LKR-8	8"
HPC LKR-11	11"

Give-Away Key Rings



Hardened spring steel wire. Bright zinc plated to resist tarnishing. So inexpensive, they can be given away with duplicate keys. Gauge is .0475. Sold in quantities of 1000.

Part No.	Diameter	Weight
HPC GAK-6	1"	2 lbs.
HPC GAK-4	3/4"	1 lb. 9 oz.
HPC GAK-3	5/8"	1 lb. 7 oz.

Pin Tumbler Tweezers



HPC PTT-4

The groove in the tip provides a firm, non-twisting grip on cylinder pins for easy loading. The tip is also milled back so that the outside diameter of a standard .115" diameter pin extends past the tip. This permits "butting" the pin against the end of the plug follower when loading the upper chambers, providing added control when holding top or master pins of varying lengths. 6" in length



HPC TPT-5

These improved pin tumbler tweezers have a pin pushing attachment that makes it easier to load top pins into a cylinder. While top pin is held in place, use forefinger to push attachment down to set pin into chamber. Pin loading wire is removable, making this ideal for loading bottom pins.

Compact Pin Tumbler Tweezers

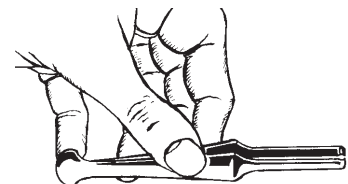

HPC PTT-5

This shorter version of pin tumbler tweezers allows you to get closer to the action. It is only 4" long. The milled tips firmly grip top and bottom pins. A compact, pocket-sized keying aid.

KEYS

Safe Change Keys

Sargent & Greenleaf

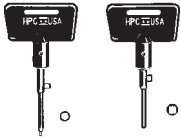

Part No.	For Lock Model
HPC SLC 1 -----	6850
HPC SLC 2 -----	6570

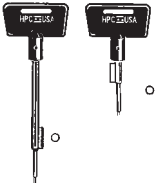

Part No.	For Lock Model
HPC SLC 5 -----	6800/6805 F/O
HPC SLC 8 -----	6580/6700

Diebold



Part No.	For Lock Model
HPC SLC 16-----	4 Tumbler/LH/Series 161 F/O
HPC SLC 14-----	4 Tumbler/RH/K & M Lock
HPC SLC 15-----	3 Tumbler/LH/Series 172 & 182



Part No.	For Lock Model
HPC SLC 18-----	Series 180 F/O

Two Keys in One

Part No.	For Lock Model
HPC SLC 19-----	Double End Key/LH Seies/180, 177 and 900

Mosler

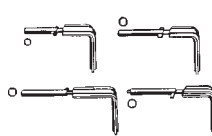

Part No.	For Lock Model
HPC SLC 9 -----	B607 F/O
HPC SLC 10-----	104
HPC SLC 11-----	B107
HPC SLC 40-----	S.T.D. Ser. F/O

Hall & York Yale



Part No.	For Lock Model
HPC SLC 24-----	Fits Hall & York Combo Locks
HPC SLC 30-----	Yale OC-8

LA Gard

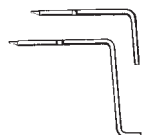

Part No.	For Lock Model
HPC SLC 42 -----	For Group 1 & 2 & 2200 Key Lock
HPC SLC 43 -----	For Group 3 & 4 Wheel Combination Locks F/O

KEY CABINETS

Single Tag KeKab®

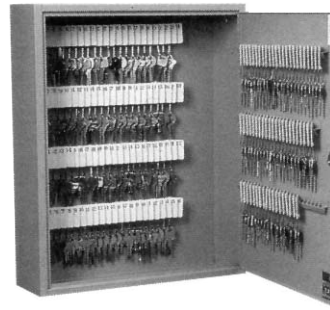

HPC KEKAB-160X

HPC's Single-Tag Key Security Control System is designed to control and provide security for 8 to 730 keys. KEKABS are ideal for home, store, or office use, where centralized or departmental key control is desired. They are designed to be mounted on a wall, near a desk, a work station, or recessed into a wall opening.

Most Single-tag KEKABS are equipped with a five-wafer tumbler cam lock with two keys. KEKABS denoted with an asterisk (*) are equipped with a high security 7 pin tubular lock with pop out T-handle. All KEKABS can be keyed-alike, master-keyed or furnished with combination lock or dual control locks at an additional charge. The "X" at the end of a stock number denotes that the cabinet is expandable.

Each HPC KEKAB® Security Control System Includes:

- **White Key Tags** with bright nickel plated snap-hooks which can hold multiple keys on each snap-hook. The tags are numbered for easy identification.
- **Durable Steel Key Racks** that are slotted to store key tags uniformly for immediate identification.
- **"Out Key" Control Tags** that are made of yellow paper. They are used for accountability (to record information on loaned keys).
- **Lock Location Data** which consists of an erasable lock location chart as part of the KEKAB-8 and numbered key control booklets with all other KEKABS.
- **Unique Two-Step Textured Epoxy Painting Process** which provides an attractive and very durable finish. The neutral sand color allows them to be hung anywhere.
- **Heavy Gauge Steel Construction** with piano hinged doors and key panels provides a sturdy location to secure your keys.

Part No.	Capacity	Dimensions
HPC KEKAB-8-----	8-----	6 ⁵ / ₈ × 5 ³ / ₄ × 2"
HPC KEKAB-30-----	30-----	12 × 8 × 2 ¹ / ₂ "
HPC KEKAB-40-----	40-----	12 × 8 × 2 ¹ / ₂ "
HPC KEKAB-60-----	60-----	17 × 13 × 3 ¹ / ₄ "
HPC KEKAB-80-----	80-----	17 × 13 × 3 ¹ / ₄ "
HPC KEKAB-120-----	120-----	17 × 13 × 3 ¹ / ₄ "
HPC KEKAB-160X-----	160-----	20 × 16 ¹ / ₂ × 5"
HPC KEKAB-240-----	240-----	20 × 16 ¹ / ₂ × 5"
HPC KEKAB-260X*-----	260-----	25 ¹ / ₄ × 18 × 5 ¹ / ₂ "
HPC KEKAB-330-----	330-----	20 × 16 ¹ / ₂ × 5"
HPC KEKAB-500*-----	500-----	25 ¹ / ₄ × 18 × 5 ¹ / ₂ "
HPC KEKAB-730*-----	730-----	25 ¹ / ₄ × 18 × 7"----F/O

Keyed-Alike Locks: Add "KA" to catalog number.
 Master-Keyed Locks: Add "MK" to catalog number.
 Dual Control Locks: Add "DC" to catalog number.
 Combination Locks: Add "CL" to catalog number.
 2 Tag Systems Available on F/O

Expansion Leaves

When your key control needs grow, so can your system. Leaves are easy to install and come with all necessary hardware, numbered tags (to the increased capacity number) and control chart.

Part No.	Increase From
HPC KEKAB-A-----	160 to 330 keys
HPC KEKAB-B-----	260 to 500 keys---F/O

KEY CABINETS

Keyable KeKab®



HPC's Keyable KeKabs eliminate the problem of how to control the key to the key cabinet. This HPC exclusive line of cabinets allows you to add your own mortise cylinder, and key it into the existing master key systems. The Keyable KeKabs are equipped with a heavy-duty lock assembly and are designed to use standard 1" mortise cylinders with an Adams Rite cam. Longer cylinders can be accommodated using spacer rings. The mortise cylinder, keys, and spacer rings are not supplied with this cabinet. Add convenience and security to the storage of your keys with the Keyable KeKab®.

Part No.	Capacity	Dimensions
HPC KEKAB-KK65	65	17 x 13 x 3 1/4"

Digital KeKab®

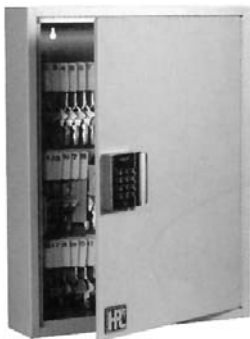

HPC's new Digital KeKabs are the best solution for storing all your keys, because they are opened by a user friendly keypad, not a key. HPC's Digital KeKab's intelligent features include 2 levels of access, instant re-programming, usage indicator, and automatic lockout. These units are battery operated and require no wiring or central processors. A low battery indicator warns when batteries are low, and special jumper ports allow access of external power in the event of battery failure.

Part No.	Capacity	Dimensions
HPC KEKAB-DL65	65	17 x 13 x 3 1/4"

KeKab Accessory Tags

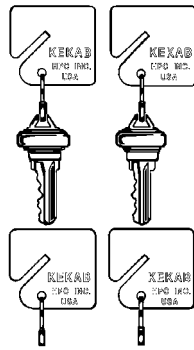

Fit all KEKABS, Key Boards, Key Racks, Carrying and Drawer KEKABS. Available numbered or plain.

Part No.	Description	Qty.
HPC PLT-1	Plain Tags	100/bx
HPC OT-100	Out Tags	100/pk
HPC SN-100	Snap Rings for PLT-1	100/bx
HPC NT-1	Numbered Tags (Specify No. Range)	20/bx

Security Locking Bars

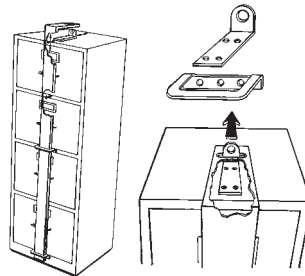

• Heavy Duty 1/2 x 1 1/2" Channel Steel
Quickly installed on steel or wood file, blue-print or tool cabinets. Packed with all necessary hasps and screws for easy, on-the-job installation.

Part No.	Drawers	Length
HPC SLB-44	4	51 1/2"
HPC SLB-45	5	59 7/8"

Medi-Kab™

Medi-Kab™ — the most secure location for medicine & pharmaceuticals.



HPC MEDI-KAB-6
The welded construction is from the finest heavy gauge steel. The Medi-Kab™ also features a rugged piano hinged door for security purposes.

All Medi-Kabs use a cam lock which can be keyed alike or keyed differently.

The two-step epoxy painting process is finished in a neutral sand color which is suitable for even the most tastefully decorated office or home. At the office, the Medi-Kab™ is designed to be mounted on a wall, near a desk, at a work station or recessed into a wall opening. In the home, the Medi-Kab™ is to be used in the kitchen, bathroom or closet.

Dimensions:
17"H x 13"W x 3 1/4"D

Emergency Key Box



Designed to house a restricted key at the immediate location. The bright red steel box has a key-locking hinged door with a plastic window. When an emergency

arises and access to a specific key is necessary, break plastic with attached hammer.

Dimensions:
6 5/8"H x 5 3/4"W x 2"D

Part No.
HPC 511
HPC 511G Replacement Plastic Insert

Over Door Key Keeper

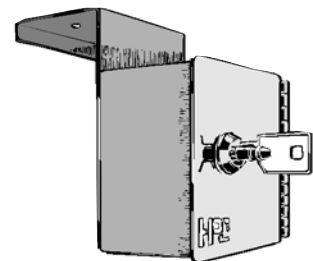

No more lost keys or lockouts! Secure one key or several in the keeper. Box is placed over the top edge of the door. When the door is closed, the top mounting screws are hidden. It has a sturdy piano hinged door and is made of 18 gauge steel with a bright zinc plated finish.

Dimensions:
3 1/4"H x 2 1/2"W x 2"D

Part No.	Description
HPC KEP-12-97	7-Pin Tubular Key Lock; (KA 3397) w/ one key

DOOR GUARDS

HPC/CylGuard™

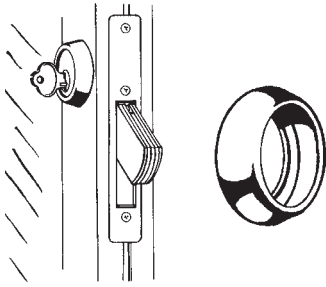

A free spinning, case hardened solid steel ring designed to guard against forcible entry.

Dimensions:

1.730" O.D. x 1.165" I.D.

Part No.	Finish
HPC CG1-AXC-EA	-----Aluminum
HPC CG1-AXD-EA	-----Duracoat Dark Bronze

Guard Plate

For doors opening out.

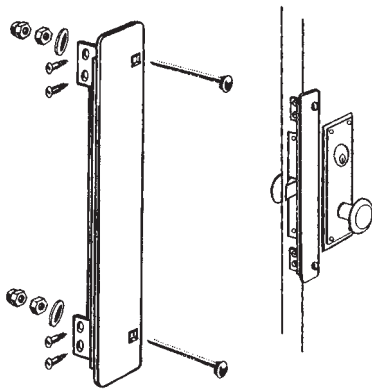

Dimensions:

13/4"W x 14"H

The VDG-10 is HPC's strongest and most popular guard plate. Made of two pieces of 16 gauge cold rolled steel welded together with a baked brown enamel finish. The guard plate offers maximum resistance to prying and forcing. It mounts onto your door with two carriage bolts and four wood screws going through the door and is anchored with a nut and cap nut on the inside. Four wood screws go into the edge of the door. Comes complete with all necessary hardware and instructions.

Part No.	Finish
HPC VDG-10	-----Duro-bronze brown enamel

Guard Plate

For doors opening out.

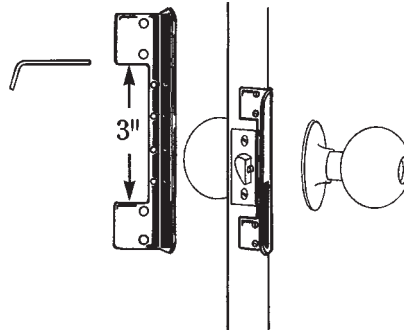

- 3" Lock Face Opening
- 1 1/16 x 5 5/8"

This guard plate is screwed directly onto the edge of the door. The flange will keep any prying tools away from the latch. The guards are made of 18 gauge cold rolled steel. Comes complete with all necessary hardware.

Part No.	Finish
HPC ODG-6	-----Bright nickel plating

Offset Guard

For doors opening out.

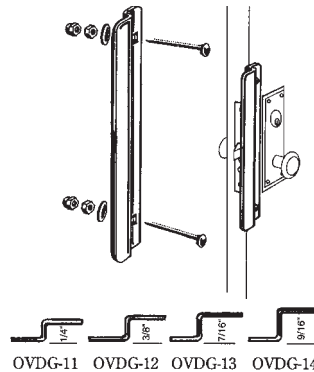

Offset Guard plates are used on vestibule doors with projecting door casings (for doors that are not flush with the frame). These plates are easily installed by drilling only two holes and using the pair of through bolts and nuts. The guards are made of 16 gauge cold rolled steel. Comes complete with all necessary hardware. Size: 1 3/16 x 14"

Part No.	Offset	Finish
HPC OVDG-11	----1/4" -----	Bright nickel plt
HPC OVDG-12	----3/8" -----	Bright nickel plt
HPC OVDG-13	----7/16" -----	Bright nickel plt
HPC OVDG-14	----9/16" -----	Bright nickel plt

HPC High Security DorGard II™

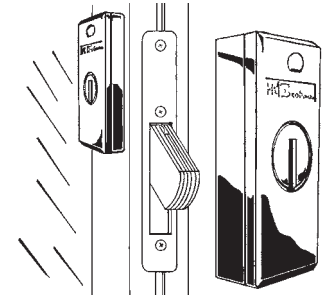

The DorGard II™ provides unsurpassed protection for lock cylinders on narrow stile aluminum doors. Using cast steel components, it creates a "vault" around the cylinder, virtually eliminating the possibility of unauthorized entry by removal of the cylinder or cylinder plug. The face plate is cast stainless steel, protecting against all common drilling equipment. The plug protector is made of case hardened steel. It rotates freely in the face plate, protecting against forcible removal of the plug. The DG2 is affixed with hardened steel bolts through the door. It can be used with any cylinders from 1 5/16" to 1 3/8" in length.

Part No.	Description
HPC DG2-AXD-10	-----1" Std. Cylinder w/ Duracoat Bronze Finish
HPC DG2-AXS-10	-----1" Std. Cylinder w/ Satin Stainless Finish
HPC DG2-BXD-10	-----1 1/8" Std. Cylinder w/ Duracoat Bronze Finish
HPC DG2-BXS-10	-----1 1/8" Std. Cylinder w/ Satin Stainless Finish
HPC DG2-CXD-10	-----1 1/4" Std. Cylinder w/ Duracoat Bronze Finish
HPC DG2-CXS-10	-----1 1/4" Std. Cylinder w/ Satin Stainless Finish