

AUXILIARY LOCKS

Security Latchlock

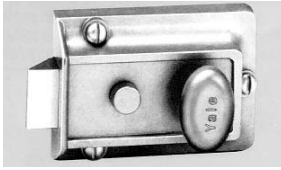

- Function: Latchbolt retracted by key outside, thumbturn inside. Latchbolt held retracted by button; can also be deadlocked by button.
- Non-handed: Can be installed on doors of either hand.
- Door: Standard application 1 1/8" to 2 1/4" thick.
- Strike: Rim strike for inswinging doors, standard; for reverse bevel outswinging doors order #8 flat strike, latchbolt is easily reversed.
- Backset: 2 3/8" standard for inswinging doors; 2 1/2" from face of stop for outswinging doors.
- Latchbolt: 1/2" throw, high density rust-resistant alloy. Brass finish.
- Material: Case and strike, high density rust-resistant alloy.
- Cylinder/Keying: YLE 1109E brass cylinder, 5 pin tumbler; two RB8 keys x E1R (PARA) section. KD only; not available KA or Masterkeyed.
- Finish: Dull brass lacquer.
- Packaging: One latchlock to a shelf box including rim strike, keys, screws for wood doors and installation instructions/ template.

Part No.	Description
YLE 80 -----	Box Pack
YLE V80-----	Visual Pack

Heavy Duty Deadbolt

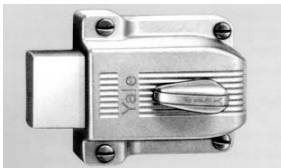

- Function: Deadbolt operated by key outside, thumbturn inside.
- Non-Handed: Can be installed on doors of either hand.
- Door: Standard application 1 1/8" to 2 1/4" thick.
- Strike: YLE 112 rim strike for inswinging doors. For reverse bevel outswinging doors order YLE 112F flat strike.
- Backset: 2 3/8" standard for inswinging doors; 2 1/2" from face of stop for outswinging doors.
- Deadbolt: 1 1/8" throw; high density rust-resistant alloy with two hardened steel inserts.
- Material: Case and strike, high density rust resistant alloy.
- Cylinder/Keying: YLE 1109E brass cylinder, 5 pin tumbler; two RB8 keys x E1R (PARA) section. Not available Masterkeyed.
- Finish: Brass lacquer.
- Packaging: One deadbolt to a shelf box including rim strike, keys, sheet metal screws for wood or metal doors and installation instructions/template.

Part No.	Description
YLE 112 -----	Aux, Sgl Cyl D-Bolt 5 pin para brass

Description: Otherwise identical to the YLE 112 but supplied with one-way installation screws that cannot be removed without drilling.

Function: Deadbolt operated by key outside, key inside.

Part No.	Description
YLE 112 14 -----	Aux, Dbl Cyl D-bolt 5 pin para brass

Jimmy-Proof Deadlock

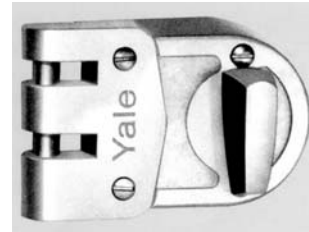

- Function: Deadbolt operated by key outside, thumbturn inside.
- Non-Handed: Can be installed on doors of either hand.
- Door: Standard application 1 1/8" to 2 1/4" thick; for doors over 2 1/4" to 3" thick, an accessory kit containing a long connecting bar, long cylinder connecting screws and a retainer is available.
- Strike: YLE 197 rim strike for inswinging or double sliding doors. For reverse bevel outswinging or single sliding doors order YLE 197F flat strike; also includes 97 spacer plate to compensate for 1/8" standard reveal of hollow metal doors.
- Backset: 2 3/8" standard for inswinging and double sliding doors; 3 1/2" from face of stop for outswinging or single sliding doors.
- Deadbolts: Two hardened steel pins interlock with the strike. Automatic shutter guard protects against forced entry even if outside cylinder is removed.
- Material: Case and strike, high density rust-resistant alloy.
- Cylinder/Keying: YLE 1109E brass cylinder, 5 pin tumbler; two RB8 keys x E1R (PARA) section. Not available Masterkeyed.
- Finish: Dull bronze lacquer.
- Packaging: One deadlock to a shelf box including rim strike, keys, sheet metal screws for wood or metal doors and installation instructions/template.

Part No.	Description
YLE 197 -----	Box Pack
YLE V197 -----	Visual Pack

Description: Otherwise identical to the YLE 197 but supplied with one way installation screws that cannot be removed without drilling.

Function: Deadbolt operated by key outside, key inside.

Part No.	Description
YLE 197 14-----	Box Pack
YLE V197 14---	Visual Pack

AUXILIARY LOCKS

3500 Series Auxiliary Bored Deadbolts



- Non-Handed: Can be installed on doors or either hand
- Door: Simple bored-hole installation 1 3/4" thick, square or beveled doors, opening in or out. Parts available for doors up to 2 1/2" thick
- Deadbolt: 1" throw, 5/8" wide x 3/4" high extruded brass with hardened steel roller pin to resist sawing
- Cylinder/Keying: 1813* brass cylinder(s), 6-pin (5-pin active) with RB8 keys x E1R (PARA) standard
- Backset: 2 3/4"
- Finish: Satin Chrome (626)

*Tailpiece changes depending on function and door thickness

Part No.	Description
YLE 3512B 626	Deadbolt, Sgl Cyl 2 3/4" E1R PARA 626
YLE 3522B 626	Deadbolt, Dbl Cyl 2 3/4" E1R PARA 626

Functions:

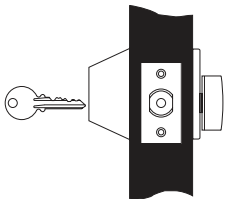

Cylinder x Thumbturn
Deadbolt operates by key outside, thumbturn inside.

Part No.:
YLE 3512B 626

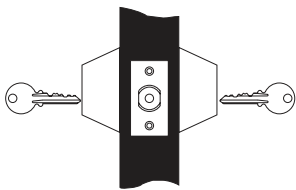

Cylinder x Cylinder
Deadbolt operated by key outside, key inside.

Part No.:
YLE 3522B 626

Parts

Part No.	Description
YLE 511A 626	2 3/8" Deadbolt 2 1/4" x 1 F/3500

PADLOCKS

840 Series

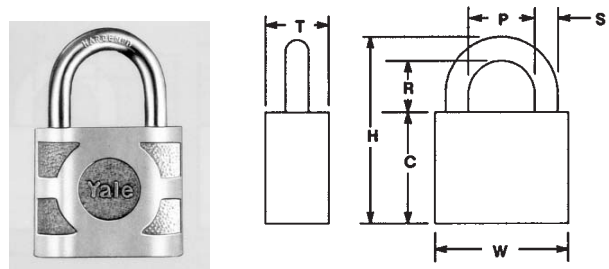

- Case: Extra heavy brass casting, clear coated finish.
- Shackle: Hardened steel, triple plated for rust resistance, chrome finish.
- Shackle Locking: Two spring loaded bolts at heel and toe of shackle.
- Keying: Pin tumbler cylinder; GA KWY 6 pin O-Bitted
- Keys: Two keys supplied with each padlock.

Dimensions & Details

Part No.	W	C	T	R	S	P	H	Plug Dia.	Max # of Pins
YLE 840	2"	1 3/4"	15/16"	15/16"	5/6"	15/16"	3"	.51	6

Part No.	Description
YLE 840 GA	GA KWY 6 Pin-O-Bitted

Padlock Chain & Clevis

Chains are used with 7300, 840, and 400 Series padlocks. All chains are double-link type.

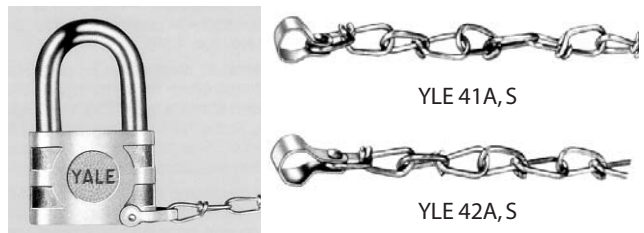

Part No.	Material	L	Shackle Dia.	Gauge Size
YLE 41A	Brass	8"	3/16" to 1/4"	15
YLE 41S	Steel	8"	3/16" to 1/4"	15
YLE 42A	Brass	8"	9/32" to 5/16"	15
YLE 42S	Steel	8"	9/32" to 5/16"	15

CYLINDRICAL LOCKSETS – LEVER

5300LN Series Key-In-Lever Lockset Grade 2



Features

- Free-wheeling lever trim for vandal resistance
- Adjustable door thickness:
Preassembled for 1 3/8" and 1 3/4" – special order available for 2"
- 3 1/2" rose covers ANSI/DHI door prep A115.18-1994 "Spider Cut Out"
- Through-bolts solidly to the door
- UL - cUL Fire Label for all functions up to 3 hours
- ADA – Meets accessibility guidelines of the Americans with Disabilities act and the requirements of the Uniform Federal Accessibility Standards and ANSI 117.1

Part No.	Description
YLE AU 5301LN 626	-----Passage, Augusta 2 3/4" ASA 626
YLE AU 5302LN 626	-----Privacy, Augusta 2 3/4" ASA 626
YLE AU 5305LN 626 LC	-----Storeroom, Augusta 2 3/4" ASA 626 LC
YLE AU 5307LN 626 LC	-----Entry, Augusta 2 3/4" ASA 626 LC
YLE AU 5308LN 626 LC	-----Classroom, Augusta 2 3/4" ASA 626 LC

Cylinders for 5300LN Series Plugs for 1802 Cylinder

*Part No.	*Part No.
YLE 1802 – _____ – _____	YLE 1802 – _____ Plug _____
Keyway Finish	Keyway Finish

*Specify keyway & finish when ordering

Available Keyways:
GA, GB, GC, GD, GE, GF, GG, GH
SA, SB, SC, SD, SE, SF, SG, SH
TA, TB, TC, TD, TE, TF, TG, TH
Available Finishes: 626

Parts For 5300LN Series

Part No.	Description
YLE 378N 626	-----2 3/8" Springlatch F/ 5300/5300LN 626
YLE 380AN 626	-----2 3/4" Deadlatch F/ 5300/5300LN 626
YLE 380N 626	-----2 3/8" Deadlatch F/ 5300/5300LN 626

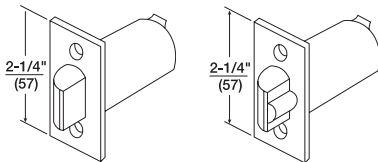

378N

380AN/380N

5400LN Series Key-In-Lever Lockset Grade 1



Features

- Free wheeling levers help extend the life of the lockset, and reduce the amount of maintenance typically required of locksets with rigid levers
- Stainless steel latchbolt provides added strength and wear resistance. Direct 1/2" throw is standard
- Wear-resistant plates in the chassis help extend the life of the lockbody and provide smoother lock operation
- Longer pins through the chassis provide greater stability and prevent rotation
- Heavy-duty lever return springs prevent lever sag and provide positive return of levers to horizontal position
- Door adjustable rose support plates allow for easy adjustment of lockset to fit doors ranging in thickness for 1 3/4" to 2 1/4"
- 3 1/2" roses cover new ANSI hollow metal door cutout

Part No.	Description
YLE AU 5401LN 613	-----Passage, Augusta 2 3/4" ASA 613
YLE AU 5401LN 626	-----Passage, Augusta 2 3/4" ASA 626
YLE AU 5402LN 613	-----Privacy, Augusta 2 3/4" ASA 613
YLE AU 5402LN 626	-----Privacy, Augusta 2 3/4" ASA 626
YLE AU 5405LN 613 LC	-----Storeroom, Augusta 2 3/4" ASA 613
YLE AU 5405LN 626 LC	-----Storeroom, Augusta 2 3/4" ASA 626
YLE AU 5407LN 613 LC	-----Entry, Augusta 2 3/4" ASA 613
YLE AU 5407LN 626 LC	-----Entry, Augusta 2 3/4" ASA 626
YLE AU 5408LN 613 LC	-----Classroom, Augusta 2 3/4" ASA 613
YLE AU 5408LN 626 LC	-----Classroom, Augusta 2 3/4" ASA 626

Cylinders for 5400LN Series Plugs for 1802 Cylinder

*Part No.	*Part No.
YLE 1802 – _____ – _____	YLE 1802 – _____ Plug _____
Keyway Finish	Keyway Finish

*Specify keyway & finish when ordering

Available Keyways:
GA, GB, GC, GD, GE, GF, GG, GH
SA, SB, SC, SD, SE, SF, SG, SH
TA, TB, TC, TD, TE, TF, TG, TH
Available Finishes: 626

Parts For 5400LN Series

Part No.	Description
YLE 107S	-----Sch Cyl Adapter Kit F/ 5400LN
YLE 14 5401 1641 999	-----Spring O/S Lever F/ 5400LN
YLE 14 5401 1642 999	-----Spring I/S Lever F/ 5400LN
YLE 14 5407 1039 048	-----Tailpiece F/ 1802 KIK CYL
YLE 694 626	-----2 3/4" Deadlatch 1/2" Throw F/ 5400LN

Functions for 5300LN and 5400LN Series Locksets:

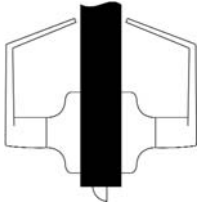

Passage or Closet Lock

For doors that do not require locking. Either lever operates latchbolt at all times.

Part No.: 5301LN
Part No.: 5401LN

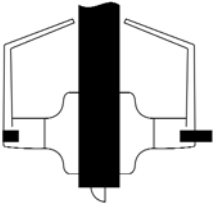

Privacy Bedroom or Bath Lock

For lavatory or other privacy doors. Either lever operates latchbolt unless outside lever is locked by pushbutton inside.* Button automatically releases when inside lever is turned or door is closed. Emergency release in outside lever. Emergency key supplied. Inside lever always active.

Part No.: 5302LN
Part No.: 5402LN

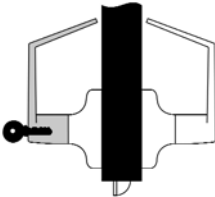

Storeroom or Closet Lock

For use on storeroom or utility, exit doors. Deadlocking latchbolt. Latchbolt operated by lever inside, key in outside lever. Outside lever always locked* while inside lever is always active.

Part No.: YLE 5305LN
Part No.: YLE 5405LN

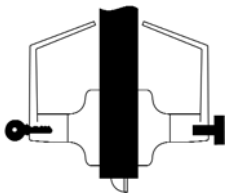

Entrance or Corridor Lock

For entrance, general home or office doors. Deadlocking latchbolt. Either lever operates latchbolt (except when outside lever is locked from inside).* Pushing turn button in inside lever locks outside lever. (Automatically releases when inside lever is turned or key is rotated in locked outside lever.) Outside lever may be retained in locked position by pushing and rotating turn button 90° clockwise to a horizontal position; not released until turn button is manually returned to the vertical position. Latchbolt is operated by key in outside lever or by rotating inside lever. Inside lever always active.

Part No.: 5307LN
Part No.: 5407LN

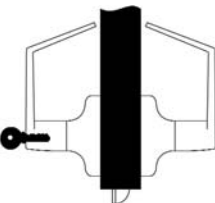

Classroom Lock

For classroom or utility room doors. Deadlocking latchbolt. Either lever operates latchbolt (except when outside lever is locked by key).* Inside lever always active. Key releases outside lever.

Part No.: 5308LN
Part No.: 5408LN

* Lever handles free wheeling in locked position.

CYLINDRICAL LOCKSET

5400 Series



The 5400 Lockset mechanism is constructed of heavy gauge cold rolled steel; all parts are zinc-plated and dichromated to assure maximum protection from rust or corrosion. It is recommended for use under normal climactic and environmental conditions.

Features

- Guardbolt:** Deadlocks the latchbolt of locking functions to resist attempts to slip the latchbolt with a thin piece of material like a plastic credit card
- Knobs:** Selection of 2 knob designs
- Door Thickness:** Adjustable for doors 1 3/8" to 2"
- Case:** 2 1/16" diameter. All functions furnished in one standard size lock case
- Latchbolt:** Standard, 1/2" throw, deadlocking or plain
- Strike:** Standard, 1 1/4" curved lip, wrought box supplied
- Backset:** Standard, 2 3/4"
- Front:** Standard, bevel 1/8" in 2"
- Reversibility:** Either right or left-hand doors swinging in or out
- Installation:** Uniform, regardless of function or trim style. The latch unit requires a 1" hole in edge of door and the lockset requires 2 1/8" hole through the door
- Screws for Front:** Phillips, flat head No. 8-8-32 x 3/4" combo screw, for both wood and metal doors
- Screws for Strikes:** Phillips, flathead No. No. 8-8-32 x 3/4"
- Finish:** Satin Chrome (626)

Series Designs:

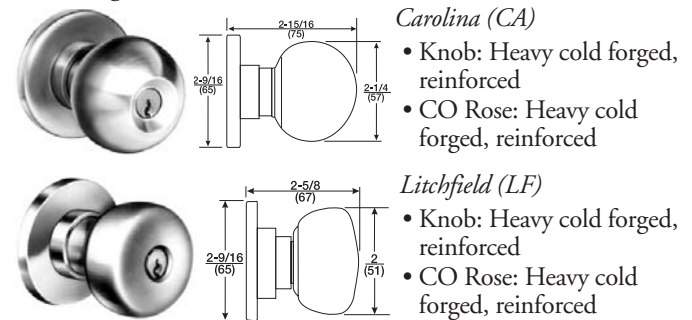

Part No.	Description
YLE CA 5405 626	Storeroom, Carolina 2 3/4" ASA E1R 626
YLE CA 5407 626	Entry, Carolina 2 3/4" ASA E1R 626
YLE CA 5408 626	Classroom, Carolina 2 3/4" ASA E1R 626
YLE LF 5405 626	Storeroom, Litchfield 2 3/4" ASA E1R 626
YLE LF 5407 626	Entry, Litchfield 2 3/4" ASA E1R 626
YLE LF 5408 626	Classroom, Litchfield 2 3/4" ASA E1R 626

Part for 5400 Series

Part No.	Description
YLE 694 626	2 3/4" Deadlatch 1/2" Throw F/ 5400 626
YLE 3480 626	3 3/4" Deadlatch 5/8" Throw F/ 5400 626

Functions

Storeroom or Closet Lock

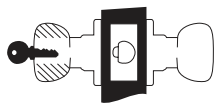

For use on storeroom, utility, exit doors. Deadlocking latchbolt. Latchbolt operated by knob inside, key in outside knob. Outside knob always rigid. Inside knob always active.

Part No.: YLE CA 5405
YLE LF 5405

Entrance, Storeroom or Corridor Lock

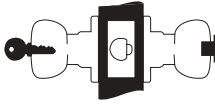

For entrance, general home or office doors. Deadlocking latchbolt. Either knob operates latchbolt. (Except when outside knob is locked from inside). Pushing turn button in inside knob locks outside knob. (Auto releases when inside knob is turned or key is rotated in locked outside knob). Outside knob may be retained in locked position by pushing and rotating turn button 90° clockwise to a horizontal position; not released until turn button is manually returned to the vertical position. Latchbolt is operated by key in outside knob or by rotating inside knob. Inside knob always active.

Part No.: YLE CA 5407
YLE LF 5407

Classroom Lock

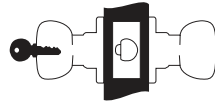

For classroom or utility room doors. Deadlocking latchbolt. Either knob operates latchbolt (except when outside knob is locked by key). Inside knob is always as active. Key releases outside knob.

Part No.: YLE CA 5408
YLE LF 5408

8800 MORTISE LOCKS

8800 Series

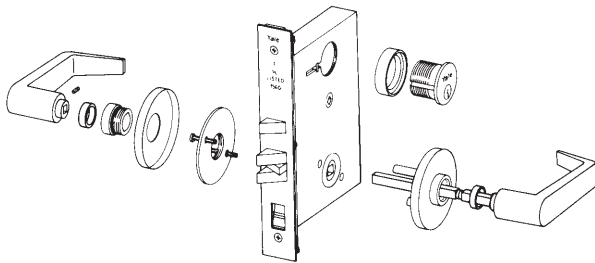

Sectional Lever Installation

All Yale 8800 Series sectional lever trims feature thru-bolted installation. This assures positive alignment of the trim with the lock case and offers an attractive appearance.

- Field reversible — Locks can be converted to accommodate the hand of the door
- Outside trim is held in place by threaded posts. The posts fit through holes in the lock case and are secured by thru-bolts from the inside trim
- Since self-aligning trim is easy to install, on-the-job labor costs may be reduced
- Each mortise lock ordered with lever trim features an internal heavy duty spring cartridge which prevents lever sag
- All Yale mortise lock trims are UL Listed for fire door applications

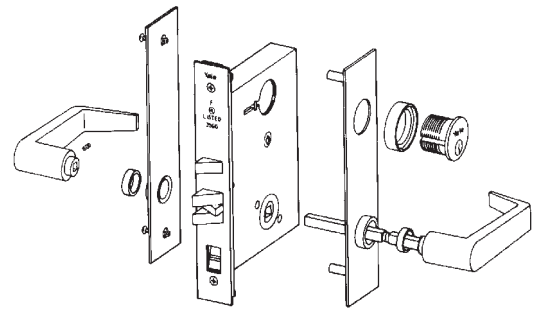

Escutcheon Lever Installation

- Field reversible — Locks can be converted to accommodate the hand of the door
- All Yale 8800 escutcheon lever trims feature thru-bolted installation
- Outside trim is held in place by threaded posts. The posts fit through the door and are secured by thru-bolts from the inside trim
- Yale outside escutcheon trims have no visible screws — great deterrent to vandalism
- Each mortise lock ordered with lever trim features an internal heavy duty spring cartridge which prevent lever sag
- All Yale mortise lock trims are UL Listed for fire door applications

8800 LEVER TRIM

Augusta Lever Trim (AUR)

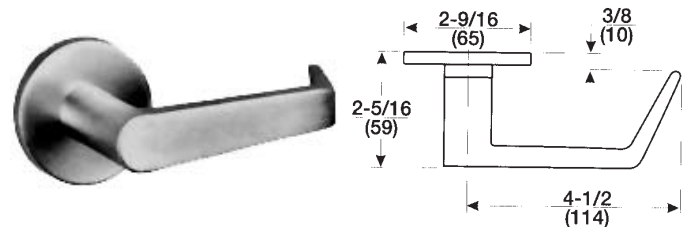

- AU Lever Handle: (solid cast)
- CO Rose: cold forged, reinforced
- Cylinder Ring: Standard, No.1765
- Material: Brass, Bronze, Stainless Steel
- Keyed functions supplied less cylinder

Part No.	Description
YLE AUR 8801FL 626 RH	Passage, Augusta x rose 626 RH
YLE AUR 8802FL 626 RH	Privacy, Augusta x rose 626 RH
YLE AUR 8805FL 626 RH LC	Storeroom, Augusta x rose 626 RH
YLE AUR 8807FL 626 RH LC	Entry, Augusta x rose 626 RH
YLE AUR 8808FL 626 RH LC	Classroom, Augusta x rose 626 RH
YLE AUR 8822FL 626 RH LC	Dormitory, Augusta x rose 626 RH
YLE AUR 8847FL 626 RH LC	Entry, Augusta x rose 626 RH

Augusta Lever Trim (AUE)

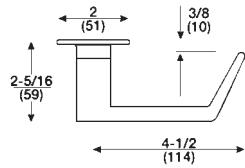

- AU Lever Handle: (solid cast)
- CO Escutcheon: 8 × 2", heavy cold forged
- Cylinder Ring: Standard, No. 1765
- Material: Brass, Bronze, Stainless Steel
- Keyed functions supplied less cylinder

Part No.	Description
YLE AUE 8801FL 626 RH	Passage, Augusta × esc 626 RH
YLE AUE 8802FL 626 RH	Privacy, Augusta × esc 626 RH
YLE AUE 8805FL 626 RH LC	Storeroom, Augusta × esc 626 RH
YLE AUE 8807FL 626 RH LC	Entry, Augusta × esc 626 RH
YLE AUE 8808FL 626 RH LC	Classroom, Augusta × esc 626 RH
YLE AUE 8822FL 626 RH LC	Dormitory, Augusta × esc 626 RH
YLE AUE 8847FL 626 RH LC	Entry, Augusta × esc 626 RH

Carmel Lever Trim (CRR)

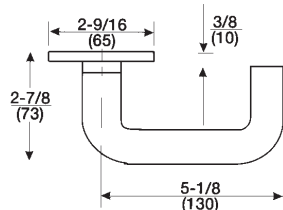

- CR Lever Handle: (solid cast), bronze-wrought, stainless steel-solid cast
- CO Rose: cold forged, reinforced
- Cylinder Ring: Standard, No. 1765
- Material: Brass, Bronze, Stainless Steel
- Keyed functions supplied less cylinder

Part No.	Description
YLE CRR 8801FL 626 RH	Passage, Carmel × rose 626 RH
YLE CRR 8802FL 626 RH	Privacy, Carmel × rose 626 RH
YLE CRR 8805FL 626 RH LC	Storeroom, Carmel × rose 626 RH
YLE CRR 8807FL 626 RH LC	Entry, Carmel × rose 626 RH
YLE CRR 8808FL 626 RH LC	Classroom, Carmel × rose 626 RH
YLE CRR 8822FL 626 RH LC	Dormitory, Carmel × rose 626 RH
YLE CRR 8847FL 626 RH LC	Entry, Carmel × rose 626 RH

Carmel Lever Trim (CRE)

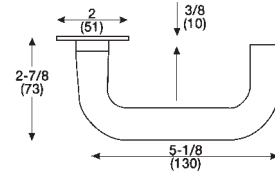

- CR Lever Handle: Brass (Solid cast), Bronze-wrought. Stainless steel-solid cast
- CO Escutcheon: 8 × 2", heavy cold forged
 - Cylinder Ring: Standard No. 1765
 - Material: Brass, Bronze, Stainless Steel
 - Keyed functions supplied less cylinder

Part No.	Description
YLE CRE 8801FL 626 RH	Passage, Carmel × esc 626 RH
YLE CRE 8802FL 626 RH	Privacy, Carmel × esc 626 RH
YLE CRE 8805FL 626 RH LC	Storeroom, Carmel × esc 626 RH
YLE CRE 8807FL 626 RH LC	Entry, Carmel × esc 626 RH
YLE CRE 8808FL 626 RH LC	Classroom, Carmel × esc 626 RH
YLE CRE 8822FL 626 RH LC	Dormitory, Carmel × esc 626 RH
YLE CRE 8847FL 626 RH LC	Entry, Carmel × esc 626 RH

8800 Series Trim Packs

Part No.	Description
YLE TRIM PACK AUE 8801 626	Trim Augusta F/ 8701
YLE TRIM PACK AUE 8802 626	Trim Augusta F/ 8702
YLE TRIM PACK AUE 8805/07/08 626	Trim Augusta F/ 8705/07/08
YLE TRIM PACK AUE 8822/47/60 626	Trim Augusta F/ 8722/47/60
YLE TRIM PACK AUR 8801 626	Trim Augusta F/ 8701
YLE TRIM PACK AUR 8802 626	Trim Augusta F/ 8702
YLE TRIM PACK AUR 8805/07/08 626	Trim Augusta F/ 8705/07/08
YLE TRIM PACK AUR 8822/47/60 626	Trim Augusta F/ 8722/47/60
YLE TRIM PACK CRE 8801 626	Trim Carmel F/ 8701
YLE TRIM PACK CRE 8802 626	Trim Carmel F/ 8702
YLE TRIM PACK CRE 8805/07/08 626	Trim Carmel F/ 8705/07/08
YLE TRIM PACK CRE 8822/47/60 626	Trim Carmel F/ 8722/47/60
YLE TRIM PACK CRR 8801 626	Trim Carmel F/ 8701
YLE TRIM PACK CRR 8802 626	Trim Carmel F/ 8702
YLE TRIM PACK CRR 8805/07/08 626	Trim Carmel F/ 8705/07/08
YLE TRIM PACK CRR 8822/47/60 626	Trim Carmel F/ 8722/47/60

Functions

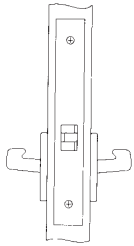

Passage Latch (F01)

For doors that do not require locking. Either knob/lever operates the latchbolt at all times.

Spindles: Levers, 3/8" only, 1173L

Part No.: 8801FL

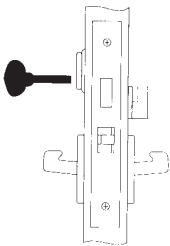

Privacy Lock (F02) (F19)

Latchbolt by knob/lever either side. Deadbolt by thumbturn inside. When the deadbolt is projected, outside knob/lever is automatically made rigid. Anti-panic operation. Turning inside knob/lever retracts the latchbolt and deadbolt simultaneously, automatically unlocking outside knob/lever. In emergency, deadbolt may be unlocking from outside by E203 emergency key supplied.

Spindles: Levers, 3/8" only, 1178L

Part No.: 8802FL

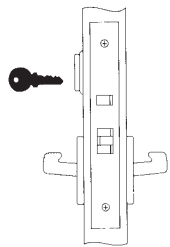

Storeroom or Closet Lock (F07)

For use on storeroom, utility, exit doors. Deadlocking latchbolt. Latchbolt by key outside, knob/lever inside. Outside knob/lever rigid at all times.

Spindles: Levers, 3/8" only, 1178L

Part No.: 8805FL

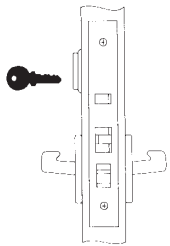

Entrance Lock (F04)

For office doors where locking is required. Deadlocking latchbolt. Latchbolt by knob/lever either side, except when outside knob/lever is set by stop work activator. When outside knob/lever is set, latch bolt is operated by key outside and knob/lever inside.

Spindles: Levers, 3/8" only, 1178L

Part No.: 8807FL

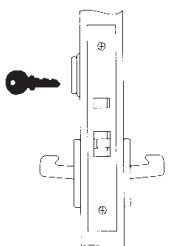

Classroom Lock (F05)

For classroom, office, or utility room doors. Deadlocking latchbolt. Latchbolt by knob/lever either side, except when outside knob/lever is set by key outside. Inside knob/lever always active.

Spindles: Levers, 3/8" only, 1178L

Part No.: 8808FL

Functions Con't

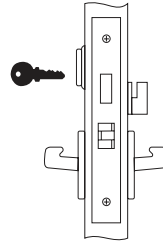

Dormitory Lock (F13)

Latchbolt by knob/lever either side. Deadbolt by key outside and thumbturn inside. When the deadbolt is projected, outside knob/lever is automatically made rigid. Anti-panic operation. Turning inside knob/lever retracts the latchbolt and deadbolt simultaneously, automatically unlocking outside knob/lever.

Spindles: Levers, 3/8" only, 1178L

Part No.: 8822FL

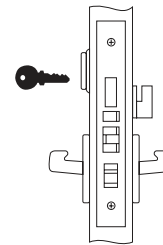

Entrance & Apartment Door Lock (F20)

Deadlocking latchbolt. Latchbolt by knob/lever either side, except when outside knob/lever is set by stopwork activator. Deadbolt by key outside, thumbturn inside. When outside knob/lever is set, key outside operates & retracts both latchbolt and deadbolt. When deadbolt is projected, outside knob/lever is automatically locked. Operating inside knob/lever automatically retracts latchbolt and deadbolt with outside knob/lever remaining locked.

Spindles: Levers, 3/8" only, 1178L

Part No.: 8847FL

Mortise Lock Body/Parts

- Field reversible — Locks can be converted to accommodate the hand of the door

Part No.	Description
YLE 8801FL RH	Passage mortise body RH
YLE 8802FL RH	Privacy mortise body 8702/8722
YLE 8805FL RH	Storeroom mortise body RH
YLE 8807FL RH	Entry mortise body RH
YLE 8808FL RH	Classroom mortise body RH
YLE 8847FL RH	Apartment mortise body RH

Strikes:

- YLE ARMOR FRT/STK 8801 630 ————Armor front/strike F/ mort
- YLE ARMOR FRT/STK 8802/22/60 630 ————Armor front/strike F/ mort
- YLE ARMOR FRT/STK 8805/08 630 ————Armor front/strike F/ mort
- YLE ARMOR FRT/STK 8807 630 ————Armor front/strike F/ mort
- YLE ARMOR FRT/STK 8847 630 ————Armor front/strike F/ mort

Cams:

- YLE 1160L ————Cam F/ mort cyl .572" ADAMS RT
- YLE 2160 ————Cam F/ mort cyl .742"

Spindles:

- YLE 1178L ————Spindle 3/8" swivel LVR x LVR
- YLE N1174 1/2 ————Spindle 5/16" KB x KB

KEYING

Key Sections/Keyways

There are three types of Yale key sections



E1R

1. Standard Simplex Keyway – Yale cylinders are supplied with the E1R (PARA) simplex keyway as standard unless otherwise specified.

2. Simplex keyways – Single keyways which are used for keyed different, keyed alike or small master key systems when only one keyway is required.



.40 Surety Sections

JA	JB	JC
JD	JE	JF
JG	JH	JK
JMK		

Standard Surety Family Shown
Restricted K Family Available

.40 Simplex Sections

E3R

3. Surety Keyways – Also referred to as multiplex keyways use a variety of different shaped keyways (the keys will not interchange). The master key section is milled to pass all the different keyways of a particular series. Surety keyways are used on large or complex master key systems.



GST



GMK



GAH GBG GCE GDF



GA GB GC GD GE GF GG GH



SMK



TMK

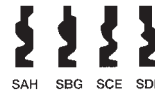

SAH SBG SCE SDF

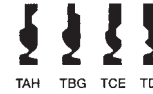

TAH TBG TCE TDF



SA SB SC SD SE SF SG SH

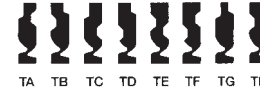

TA TB TC TD TE TF TG TH

**The section of the key is determined by viewing the key from the bow towards the tip.*

RIM CYLINDERS

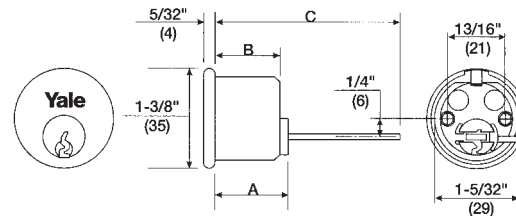

Application	Mat'l	# of Pins	Dim. A	Dim. B	Dim. C	Connect. #1145	Bar List # #1147	Std Cyl. Ring
Std Rim Locks	-Brass Bdy	--6	---17/32	--13/32	--23/4	-----35/8	-----	1762
Exit Device	----Brass Body, Trim or S.S. Scalp							

Part No.

*YLE 1109 - _____ - _____
Keyway Finish

*Specify keyway & finish when ordering

MORTISE CYLINDERS

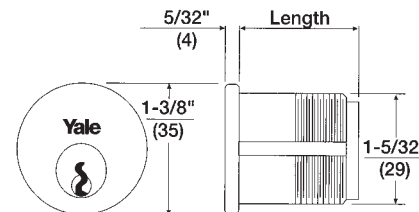

Part No.

*YLE 2153 -114 _____ - _____
Keyway Finish

Description

1 1/4 Mortise cylinder

*YLE 2153 -118 _____ - _____
Keyway Finish

1 1/8 Mortise cylinder

Plug For Mortise Cylinder:

*YLE 2153 -PLUG -114 _____ - _____

*YLE 2153 -PLUG -118 _____ - _____

*Specify keyway & finish when ordering

KEYING KITS & KEY BLANKS

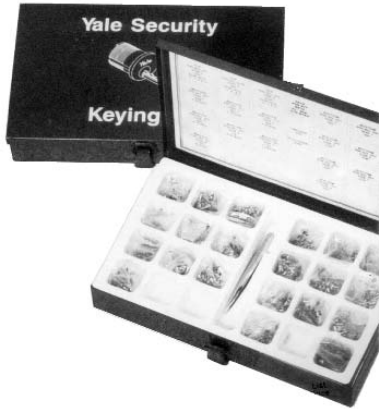

Complete with 100 of each bottom pin, master pin, drivers and springs. Plus a plug follower and tweezers.

Part No.	Description
YLE SK-12	(019 Step)

KEY BLANKS



R BOW

Part No.	Description
*YLE RN11 - _____ Keyway	6 Pin Nickel Silver Key blank

*Specify keyway when ordering

Available Keyways: GA, GB, GC, GD, GE, GF, GG, GH, GMK, GST
SA, SB, SC, SD, SE, SF, SG, SH, SMK
TA, TB, TC, TD, TE, TF, TG, TH, TMK
PARA