

PIN TUMBLER CYLINDER CAM LOCKS

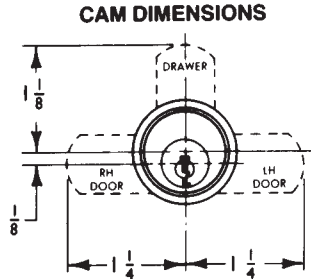

Through the use of a shifter, the 360° key turn turns the cam 90° in either direction. Actual application determines which cam position is the locked position. Each lock is furnished with an alternate cam for opposite cam turn.

Applications: solid lines show locked position of cam	Position of shifter on back of lock	Applications: solid lines show locked position of cam	Position of shifter on back of lock

Brass Construction

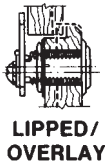

**LIPPED/
OVERLAY**

**C8103
C8109**



APPLICATION — For drawer, R.H. or L.H. doors. C8103 and C8109 are for lipped or overlay construction. For overlay application, the combined thickness of front and frame cannot exceed the cylinder length. Also see overlay detail below. The other locks are for flush application.

OPERATION — 90° cam turn, key removable in both locked and unlocked positions.

KEYING — Will key together with all other pin tumbler locks using D4291 key blank except for mail box locks.

See table for available keying. Masterkeying to GM1.

PACKAGING — Supplied with two keys, trim washer, spur washer for wood, mounting nut and two cams. If flat washer (for metal) is needed, order C2015-2C separately.

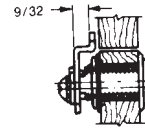

FLUSH

**C8102
C8106
C8108**

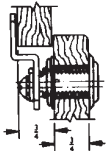

OVERLAY

Specific cams to be used with C8102 lock are available for overlay construction using a 3/4" thick front and 3/4" thick frame.

Part No.	Type of Mounting	Cylinder Length	Maximum Material Thickness	KA* Codes	Key Changes		Case Quantity	Reference Number	Key Blank
					KD	MKKD			
C8102-26D	Flush	1-1/16"	3/4"	4	850	650	10	M2-0106DF	D4291
C8102-4	Flush	1-1/16"	3/4"	2	850	—	10	M2-0106DF	D4291
C8103-26D	Lipped/	1-3/16"	7/8"	4	850	650	10	M2-0106L	D4291
C8103-4	Overlay	1-3/16"	7/8"	2	850	—	10	M2-0106L	D4291
C8106-26D	Flush	1-7/16"	1-1/8"	4	850	650	10	M2-0106MF	D4291
C8106-4	Flush	1-7/16"	1-1/8"	2	850	—	10	M2-0106MF	D4291
C8108-26D	Flush	1-3/4"	1-3/8"	4	850	650	10	M2-0106NF	D4291
C8108-4	Flush	1-3/4"	1-3/8"	2	850	—	10	M2-0106NF	D4291
C8109-26D	Lipped/	1-3/4"	1-1/2"	4	850	650	10	M2-0106N	D4291
C8109-4	Overlay	1-3/4"	1-1/2"	2	850	—	10	M2-0106N	D4291

*Key Codes used: 2 Codes — 107 and 915.
4 Codes — 101, 103, 107 and 915.

PIN TUMBLER DRAWER LOCKS

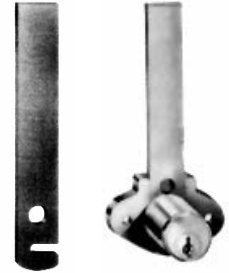
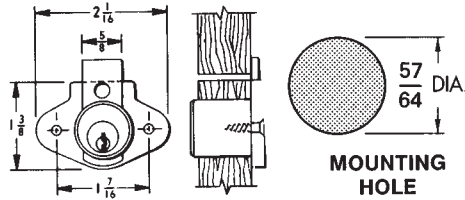

C8163

APPLICATION — For drawers. Surface mounted. Requires 7/8" dia. hole for cylinder.

OPERATION - Key removable in both locked and unlocked positions.

KEYING — Will key together with all other pin tumbler locks using D4291 key blank except for mail box locks. See table for available keying. Masterkeying to GM1.

PACKAGING — Supplied with two keys and mounting screws. If trim ring is required, order C2017 separately.

"The Advantage Plus"

C8163 locks feature easy removal of cylinder from lock housing while lock remains in place. Bolt has access hole for cylinder retention screw at back of lock. U.S. Patent No. 4,899,563

Extended bolt for C8163 drawer lock provides 3" extension, can be cut to required length. Packed 20 pcs. per bag.

Part No.	Installation	Bolt Type	Cylinder Length	Bolt Travel	KA* Codes	Key Changes		Case Quantity	Reference Number	Key Blank
						KD	MKKD			
C8163-26D	Drawer	Dead	15/16"	11/32"	4	850	650	10	M2-3705	D4291
C8163-4	Drawer	Dead	15/16"	11/32"	4	850	650	10	M2-3705	D4291

PIN TUMBLER DOOR & DRAWER LOCKS

"THE ADVANTAGE PLUS" CAM LOCKS

The locks are fastened in place with two screws for easy installation. Re-keying or servicing is accomplished by removing the cam retaining screw and cam. Use a 5/64" allen wrench to remove the plug cylinder assembly. The mounting plate remains installed on the cabinet. Re-key as required and reinstall cylinder plug assembly on mounting plate.

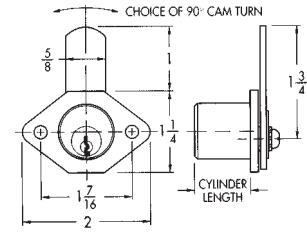
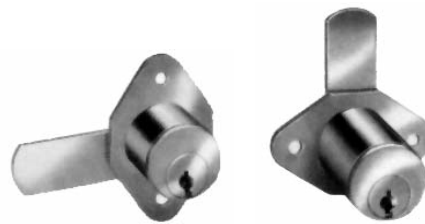

One lock, two functions door or drawer

C8183

C8188

Assembled as a door lock Assembled as a Drawer lock

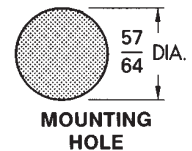

U.S. PATENT NO. 5.678.438

APPLICATION — For drawer, R.H. or L.H. doors. C8183 assembled for door function. C8188 assembled for drawer function.

OPERATION - 90° cam turn, key removable in both locked and unlocked positions.

KEYING — Will key together with all other pin tumbler locks

using D4291 key blank except for mail box locks. See table for available keying. Masterkeying to GM1. **PACKAGING** — Supplied with two keys, extra backplate, two cams and two mounting screws. If trim ring is required, order C2017 separately. **Note:** If formed cam is required, order C7113 or C7116.

Part No.	Type of Mounting	Cylinder Length	Maximum Material Thickness	KA* Codes	Key Changes		Case Quantity	Reference Number	Key Blank
					KD	MKKD			
C8183-26D	Flush	7/8"	7/8"	4	850	650	10	M2-8183	D4291
C8188-26D		1-3/8"	1-3/8"	4	850	650	10	M2-8188	D4291

*Key Codes used: 4 Codes—101, 103,107 and 915.

PIN TUMBLER DOOR & DRAWER LOCKS



C8160

APPLICATION — Replacement lock housing and cylinder for drawers with 7/8" thick fronts. Half mortise design.

OPERATION - Key removable in both locked and unlocked positions. Interchangeable cylinders are attached or removed through the use of a special key at back of lock.

KEYING — Keyed different (100 changes).

PACKAGING — C8160 cylinder supplied with two keys. C8161 lock housing supplied with cylinder removal key and mounting screws.

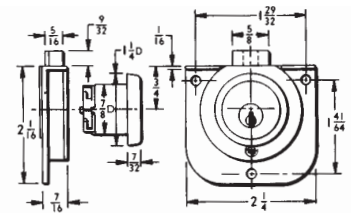

C8161

Part No.	Type of Mounting or Installation	Bolt Type	Minimum Material Thickness	Bolt Travel	Key changes KD	Case Quantity	Reference Number	Key Blank
C8160-26D	In Housing	—	—	—	100	10	M2-3720-025	D4292
C8161-26	Drawer	Dead	7/8"	9/32"	—	10	M3-3720-011	—

PIN TUMBLER MAILBOX LOCKS

GENUINE FACTORY REPLACEMENT LOCKS

APPLICATION – For doors on architectural mail boxes serviced by United States Postal Service.

OPERATION – 90° cam turn. See drawing for specific operation. Key removal in locked position only.

KEYING – Available keyed differently only (100 changes).

PACKAGING – Supplied with two keys and a spring mounting clip. C8720 furnished with trim ring.

*C8712 and C8720 are provided with a threaded cylinder, with proper clip grooving.

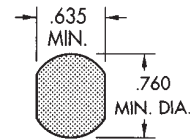

Mounting Hole for All Locks

Spring Mounting Clip

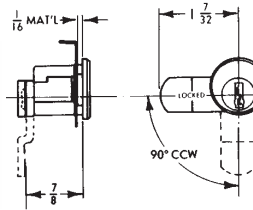

C8710

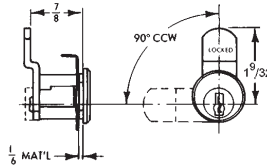

C8711

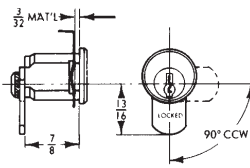

C8712*

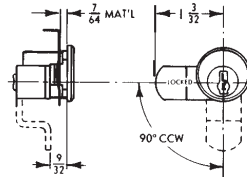

C8713

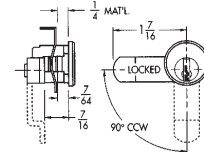

C8714

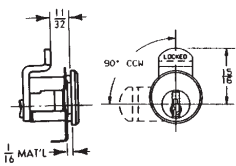

C8715

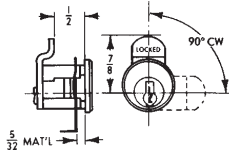

C8716

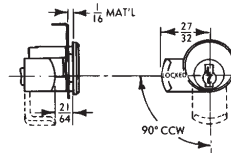

C8717

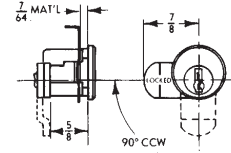

C8718

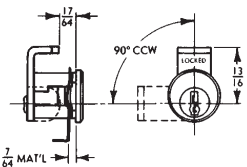

C8719

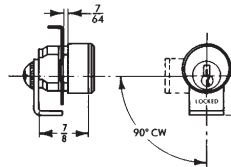

C8720*

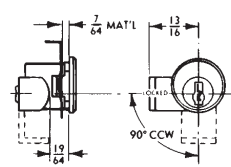

C8721

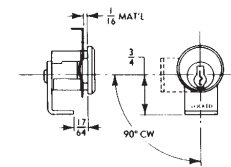

C8722

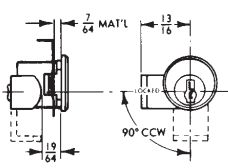

C8723

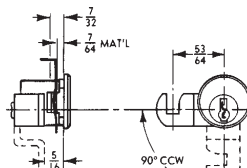

C8724

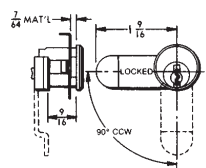

C8725

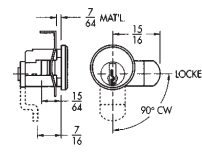

C8726

PIN TUMBLER MAILBOX LOCKS

Part No.	Locked Cam Position	Direction of Turn to Open	Replaces	Key Changes KD	Case Quantity	Key Blank
C8710	Left	90° c/cw	Bommer Industries	100	25	D4291
C8711	Up	90° c/cw	Bommer Industries	100	25	D4291
C8712	Down	90° c/cw	Bommer Industries	100	25	D4291
C8713	Left	90° c/cw	Auth Electric — Also replaces Bommer Lock B25-300 used on Bommer Box No. 9015 (sleeve inside box must be removed)	100	25	D4291
C8714	Left	90° c/cw	American Device	100	25	D4291
C8715	Up	90° c/cw	Florence Mfg.	100	25	D4291
C8716	Up	90° cw	S.H. Couch	100	25	D4291
C8717	Left	90° c/cw	Nutone	100	25	D4291
C8718	Left	90° c/cw	Cutler Mail Chute	100	25	D4291
C8719	Up	90° c/cw	Miami-Carey	100	25	D4291
C8720	Down	90° cw	Dura Steel	100	25	D4291
C8721	Left	90° c/cw	Permabit — XL-201	100	25	D4291
C8722	Down	90° cw	Dura Steel — XL-202	100	25	D4291
C8723	Left	90° c/cw	Jensen General	100	25	D4291
C8724	Left	90° c/cw	Bommer Industries	100	25	D4291
C8725	Left	90° c/cw	Cutler Federal	100	25	D4291
C8726	Right	90° cw	Riopel — Canada	100	25	D4291

PIN TUMBLER "MULTI-CAM" MAILBOX LOCKS

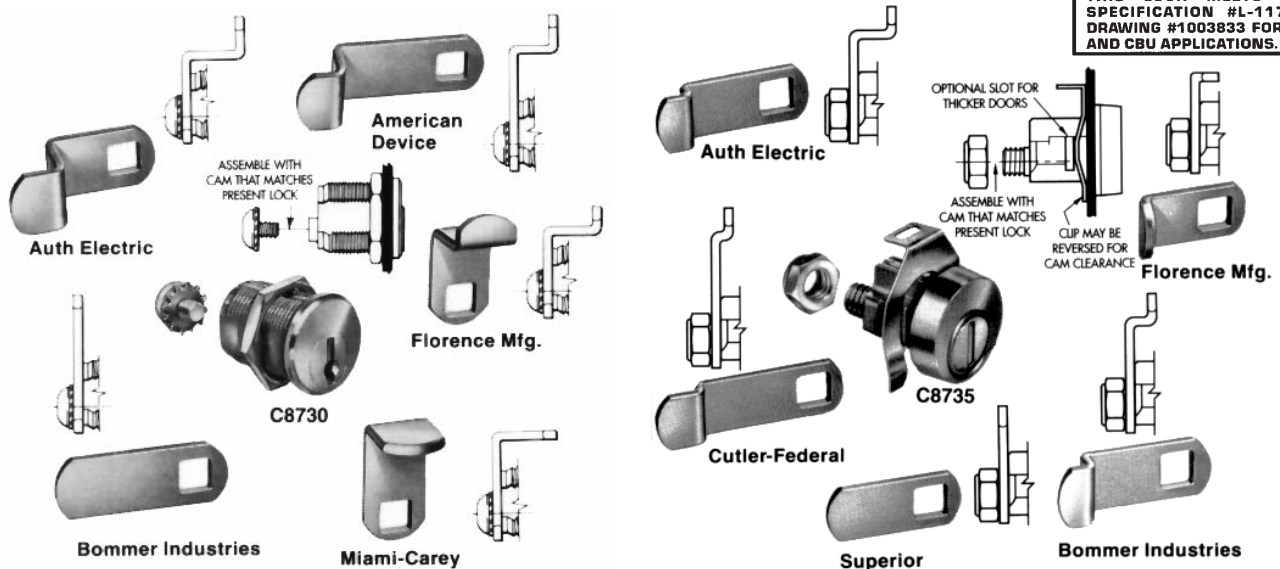

THIS LOCK MEETS U.S.P.S. SPECIFICATION #L-1172 AND DRAWING #1003833 FOR NOCBU AND CBU APPLICATIONS.

APPLICATION — Interior architectural mail boxes used in apartments, condominiums, schools, lobbies. Nut mounted

OPERATION — 90° counter-clockwise cam turn to open. Key removable in locked position only.

KEYING — Available keyed differently only (100 changes)

PACKAGING — Supplied with selection of five cams, two keys, mounting nut and cam screw.

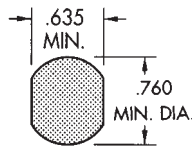

Mounting Hole for All Locks

APPLICATION — Exterior pedestal-mounted neighborhood boxes. Has keyway dust shutter for lock protection. Clip mounted.

OPERATION — 90° clockwise cam turn to open. Key removable in locked position.

KEYING — Available keyed differently only (100 changes)

PACKAGING — Supplied with a selection of five cams, three keys, mounting clip, cam locking nut.

Part No.	Installation	Direction of Turn to Open	Key Changes KD	Case Quantity	Key Blank
C8730	Architectural mail box fronts	90° c/cw	100	25	D4291
C8732	Same as C8735 w/o cams	90° cw	100	25	D4291
C8733	Same as C8735 w/o cams	90° c/cw	100	25	D4291
C8735	Door of pedestal mounted neighborhood boxes	90° cw	100	25	D4291

DISC TUMBLER CYLINDER CAM LOCKS

MOUNTING HOLES FOR ALL CAM LOCKS

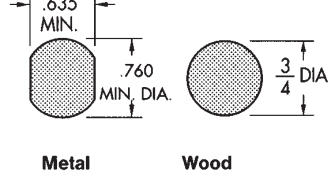

CAM DIMENSIONS

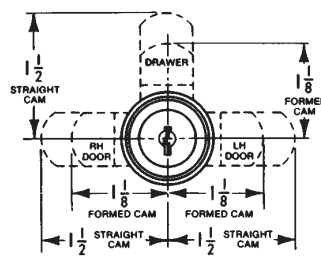

LOCK APPLICATION

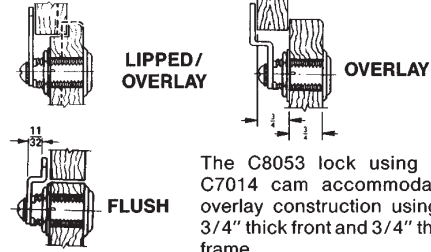

APPLICATION — For drawers, R.H. or L.H. doors with lipped/overlay construction (straight cam) or flush construction (formed cam). For overlay application, the combined thickness of front and frame cannot exceed the cylinder length. Also see overlay detail at above right.

OPERATION - 90° cam turn on all locks. Key removable in both locked and unlocked positions.

KEYING — Will key together with all other disc tumbler locks using D8785 key blank. See table for available keying. Master-keying to E41A using D8783 key blank.

PACKAGING — Supplied with two keys, trim washer, spur washer (for wood), mounting nut and two cams. If flat washer (for metal) is needed, order C2015-2C separately.



C8051 C8052, C8053, C8054, C8055
Locks furnished with straight cams assembled

Part No.	Type of Mounting	Cylinder Length	Maximum Material Thickness	KA* Codes	Key Changes		Case Quantity	Reference Number	Non MK Key Blank
					KD	MKKD			
C8051-14A	Lipped/Overlay or Flush	7/16"	7/64"	6	200	200	25	M4-0553	D8785
C8051-3		7/16"	7/64"	3	200	—	25	M4-0553	D8785
C8052-14A		5/8"	15/64"	6	200	200	25	M4-0054	D8785
C8052-3		5/8"	15/64"	3	200	—	25	M4-0054	D8785
C8054-14A		15/16"	5/8"	6	200	200	25	M4-0054B	D8785
C8054-3		15/16"	5/8"	3	200	—	25	M4-0054B	D8785
C8054-4G		15/16"	5/8"	3	200	—	25	M4-0054B	D8785
C8053-14A		1-3/16"	7/8"	6	200	200	25	M4-0054C	D8785
C8053-3		1-3/16"	7/8"	6	200	200	25	M4-0054C	D8785
C8053-4G		1-3/16"	7/8"	6	200	200	25	M4-0054C	D8785
C8055-14A		1-7/16"	1-1/8"	6	200	200	25	M4-0054L	D8785
C8055-3		1-7/16"	1-1/8"	6	200	200	25	M4-0054L	D8785
C8055-4G		1-7/16"	1-1/8"	6	200	200	25	M4-0054L	D8785

*Key Codes used: 3 Codes — C346A, C413A and C415A.
6 Codes — C346A, C390A, C413A, C415A, C420A and C642A.

DISC TUMBLER REVERSIBLE CAM LOCKS

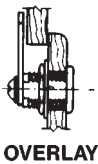

OVERLAY

Lock furnished with straight cam assembled



C8062

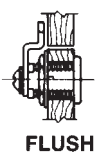

FLUSH

APPLICATION — For drawers, R.H. or L.H. doors with overlay (straight cam) or flush (formed cam) construction. For overlay application, the combined thickness of front and frame cannot exceed the 7/8" cylinder length. See above for mounting hole detail.

OPERATION — 90° cam turn. Key removable in both locked and unlocked positions.

KEYING — Reversible key operation. Keyed to SK Series; does not key with other disc tumbler locks in this catalog. See table for available keying.

PACKAGING — Supplied with two keys, spur washer (for wood), mounting nut and two cams. If flat washer (for metal) is needed, order C2015-2C separately.



Reversible Key

Part No.	Type of Mounting	Cylinder Length	Maximum Material Thickness	KA* Codes	Key Changes KD	Case Quantity	Reference Number	Key Blank
C8062-14A	Overlay or Flush	7/8"	9/16"	1 SK1	100	25	M4-0300	D8777

DISC TUMBLER CYLINDER CAM LOCKS

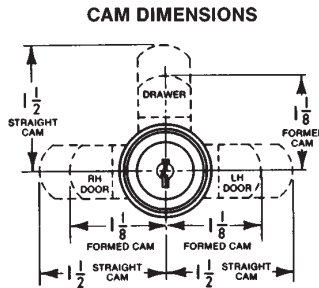
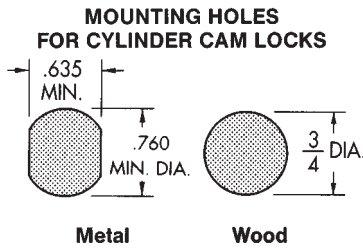

LOCK APPLICATION

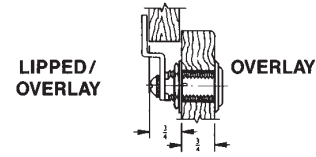

The C8073 lock using the C7014 cam accommodates overlay construction using a 3/4" thick front and 3/4" thick frame.

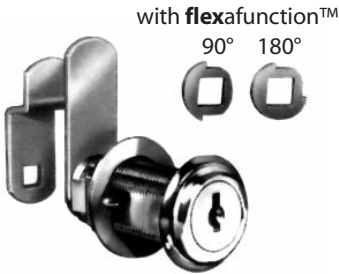

All locks feature flexafunction™
Stop washers provide for either 180° or 90° cam turn.

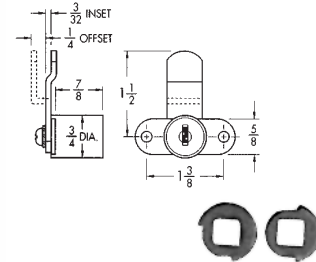

90° 180° with Flexafunction™

C8060, C8073, C8075. Assembled with straight cam and 90° rotation

C8080

APPLICATION — For drawers, R.H. or L.H. doors with lipped/overlay construction (straight cam) or flush construction (formed cam). For overlay application, the combined thickness of front and frame cannot exceed the cylinder length. Also see overlay detail at above right.

OPERATION - Choice of either 90° or 180° cam turn. Key removable in both locked and unlocked positions.

KEYING — Will key together with all other disc tumbler locks using D8785 key blank. See table for available keying. Masterkeying to E41A using D8783 key blank.

PACKAGING — Supplied with two keys, trim washer, spur washer (for wood), mounting nut, two cams and two stop washers. If flat washer (for metal) is needed, order C2015-2C separately.

APPLICATION — For doors and drawers. Surface mounted. Requires 3/4" dia. hole for cylinder.

OPERATION - Choice of either 90° or 180° cam turn. Key removable in both locked and unlocked positions.

KEYING — Will key together with all other disc tumbler locks using D8785 key blank. See table for available keying. Masterkeying to E41A using D8783 key blank.

PACKAGING — Supplied with two keys, two mounting screws, two formed cams and two stop washers. Assembled for 90° cam turn.

Part No.	Type of Mounting	Cylinder Length	Maximum Material Thickness	KA* Codes	Key Changes		Case Quantity	Reference Number	Non MK Key Blank
					KD	MKKD			
C8060-14A	Lipped/Overlay or Flush	1-3/4"	1-7/16"	6	200	200	25	M4-8060	D8785
C8060-3		1-3/4"	1-7/16"	6	200	200	25	M4-8060	D8785
C8060-4G		1-3/4"	1-7/16"	6	200	200	25	M4-8060	D8785
C8073-14A		1-3/16"	7/8"	6	200	200	25	M4-8073	D8785
C8073-3		1-3/16"	7/8"	6	200	200	25	M4-8073	D8785
C8073-4G		1-3/16"	7/8"	6	200	200	25	M4-8073	D8785
C8075-14A		1-7/16"	1-1/8"	6	200	200	25	M4-8075	D8785
C8075-3		1-7/16"	1-1/8"	6	200	200	25	M4-8075	D8785
C8075-4G		1-7/16"	1-1/8"	6	200	200	25	M4-8075	D8785
C8080-14A		7/8"	7/8"	6	200	200	25	M4-8080	D8785
C8080-3		7/8"	7/8"	6	200	200	25	M4-8080	D8785
C8080-4G		7/8"	7/8"	6	200	200	25	M4-8080	D8785

*Key Codes used: 6 Codes — C346A, C390A, C413A, C415A, C420A and C642A.

SCREWDRIVER CAM LATCH



C8065

90° 180° with flexafunction™

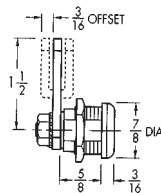

APPLICATION — For drawers or doors that do not require a key for locking.
OPERATION — flexafunction™ feature provides choice of 90° or 180° cam turn. Cams are double punched for flexibility in mounting latch.
PACKAGING — Supplied with two cams, two stop washers, spur washer and mounting nut.

Part No.	Type of Mounting	Cylinder Length	Maximum Material Thickness	Case Quantity	Reference Number
C8065-14A	Lipped, Overlay or Flush	5/8"	1/4"	25	M6-4540

DISC TUMBLER DOOR AND DRAWER LOCKS



APPLICATION — For drawers and doors. Surface mounted. Requires 7/8" dia. hole for cylinder.
OPERATION — Key removable in both locked and unlocked positions, except C8706.
KEYING — Will key together with all other disc tumbler locks using D8785 key blank. See table for available keying. Masterkeying to E41A using D8783 key blank.
PACKAGING — Supplied with two keys and mounting screws. C8706 furnished with strike. If trim ring is required, order C2017 separately.

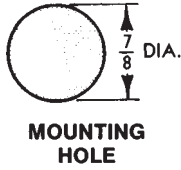

Part No.	Installation	Bolt Type	Cylinder Length	Bolt Travel	KA* Codes	Key Changes		Case Quantity	Reference Number	Non MK Key Blank
						KD	MKGD			
C8703-14A	Drawer	Dead	15/16"	11/32"	6	200	200	25	M4-6707-170	D8785
C8703-3	Drawer	Dead	15/16"	11/32"	6	200	200	25	M4-6707-170	D8785
C8703-4G	Drawer	Dead	15/16"	11/32"	6	200	200	25	M4-6707-170	D8785
C8704-14A	Door	Dead	15/16"	11/32"	6	200	200	25	M4-6707-172	D8785
C8704-3	Door	Dead	15/16"	11/32"	6	200	200	25	M4-6707-172	D8785
C8704-4G	Door	Dead	15/16"	11/32"	6	200	200	25	M4-6707-172	D8785
C8705-14A	Drawer	Dead	1-3/16"	11/32"	3	200	200	25	M4-6707-171	D8785
C8705-3	Drawer	Dead	1-3/16"	11/32"	3	200	200	25	M4-6707-171	D8785
C8705-4G	Drawer	Dead	1-3/16"	11/32"	3	200	-	25	M4-6707-171	D8785
C8706-3	Drawer	Spring	15/16"	9/32"	3	200	-	25	M4-6708-170	D8785
C8803-14A	Drawer	Dead	15/16"	11/32"	6	200	200	25	M4-8803-001	D8785
C8803-3	Drawer	Dead	15/16"	11/32"	6	200	200	25	M4-8803-001	D8785
C8803-4G	Drawer	Dead	15/16"	11/32"	6	200	200	25	M4-8803-001	D8785

*Keying Codes used: 3 Codes — C346A, C413A and C415A.
 6 Codes — C346A, C390A, C413A, C415A, C420A and C642A.

DISC TUMBLER GANG LOCK



Cylinder is located at top of pedestal



Saddle reverses for mortise application



D8090



Additional 7/8" x 1/8" deep dado for bar required on inside of panel.

APPLICATION — For locking drawers in desk pedestals and other multiple drawer applications. Requires 7/8" dia. hole for cylinder and dado for bar, measuring 7/8" x 1/8" deep on inside of panel.

OPERATION — Key removable in both locked and unlocked positions. Turning the key locks all drawers simultaneously (drawers must be in closed position). Bar moves studs into notch in drawer or slide, thus preventing drawer movement.

KEYING — Will key together with all other disc tumbler locks using D8785 key blank. See table for available keying. Masterkeying to E41A using D8783 key blank.

PACKAGING — Supplied with two keys, three locking studs, three stud slides, saddle and mounting screws. If trim ring is required, order C2017 separately.

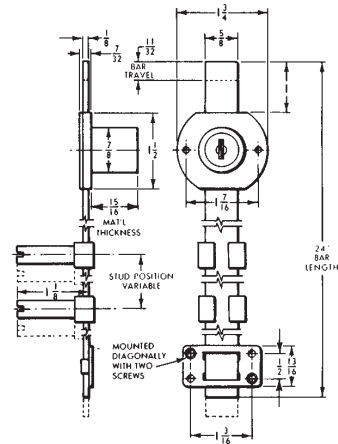

Part No.	Installation	Bar Operation	Cylinder Length	Bar Travel	KA* Codes	Key Changes		Case Quantity	Reference Number	Non MK Key Blank
						KD	MKGD			
D8090-14A	Desk Pedestals or Similar Multi-Drawer Conditions	Dead Locking	15/16"	11/32"	6	200	200	5	M4-6709-124	D8785
D8090-3			15/16"	11/32"	6	200	-	5	M4-6709-124	D8785
D8090-4G			15/16"	11/32"	6	200	-	5	M4-6709-124	D8785

*Key Codes used: 6 Codes — C346A, C390A, C413A, C415A, C420A and C642A.

DISC TUMBLER FURNITURE LOCKS

REMOVA CORE™

Now an entire furniture locking system can be changed in a matter of minutes, not days through flexible key control.



It's Easy!



A special control key simply unlocks the core for easy removal from the front of the lock. The replacement core slips right in and you have it, security restored! Replacement cores are readily available.

D8779 – Control Key

Small Diameter Furniture Locks – Lock Core... One plug Fits All!

Housing assemblies and plug cores are packaged and sold separately

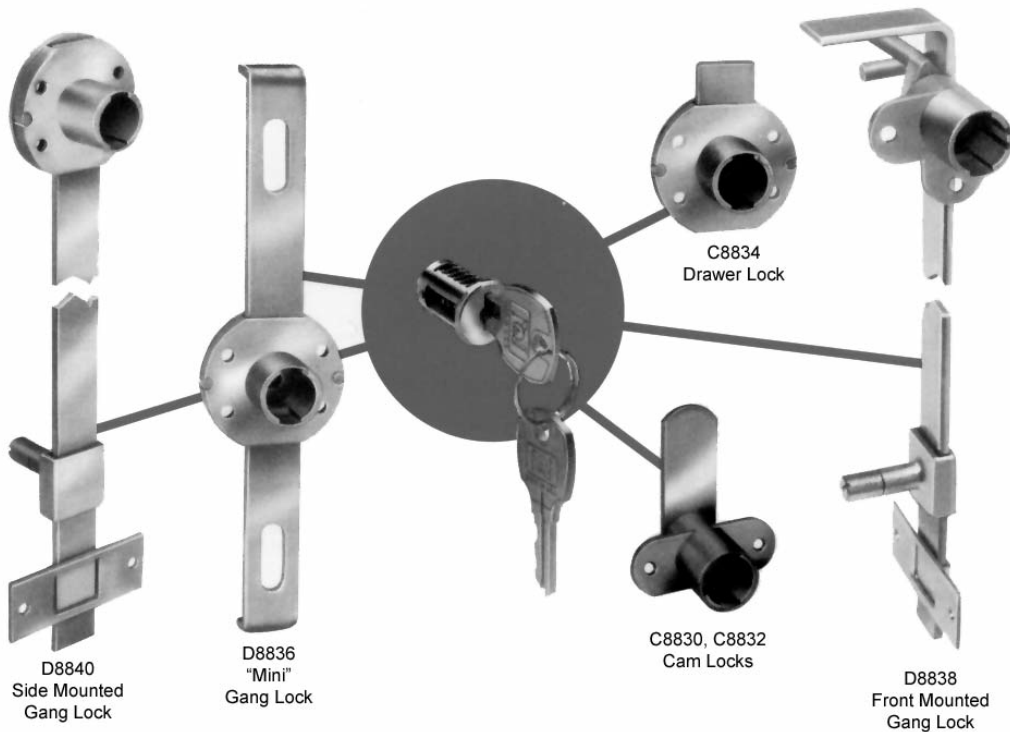

PLUG CORE FOR FURNITURE LOCKS



C8850

Part No.	KA* Codes	KD Codes	Case Quantity	Key Blank
C8850-14A	20	200	25	D8783
C8850-3	20	200	25	D8783
C8850-19	20	200	25	D8783

*Key Codes used: D003A, D054A, D071A, D084A, D091A, D177A, D233A, D256A, D284A, D313A, D346A, D362A, D390A, D413A, D415A, D420A, D435A, D512A, D554A and D642A.

APPLICATION — One Plug Fits All for RemovaCore locks on furniture applications.

OPERATION - In all RemovaCore applications, key is removable in both locked and unlocked positions.

KEYING — All Cores are Masterkeyed to E13A. Will key together with all other disc tumbler locks using D8783 key blank, except C8051 and C8052. See table for available keying. KA to 20 changes, including all six standard disc tumbler codes.

PACKAGING — Supplied with two keys.

DISC TUMBLER FURNITURE LOCKS

These locks all feature: **REMOVACORE™**



C8830 (90°) Cam Lock
C8832 (180°) Cam Lock (shown)
Can also be used with pin cams

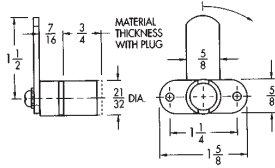

CAM LOCKS

APPLICATION — For wood pedestals, door or drawer, R.H. or L.H. Surface Mounted. For flipper door use C7015 offset cam and C2003 strike.
OPERATION — Choice of 90° or 180° cam rotation, CCW to lock.
KEYING — Order core plug separately, C8850.
PACKAGING — Housing assembly supplied with two mounting screws and straight cam. Housings are unplated.

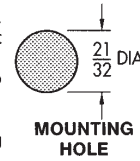

Part No.	Description	Type of Installation	Cam Rotation	Lock Cylinder Length	Maximum Material Thickness	Case Quantity
C8830	Housing Assembly	Pedestal	90°	3/4"	3/4"	25
C8832	Housing Assembly	Pedestal	180°	3/4"	3/4"	25



Use C8850 Core

Side Mounted Two Drawer "Mini" Gang Lock

Drawer Lock

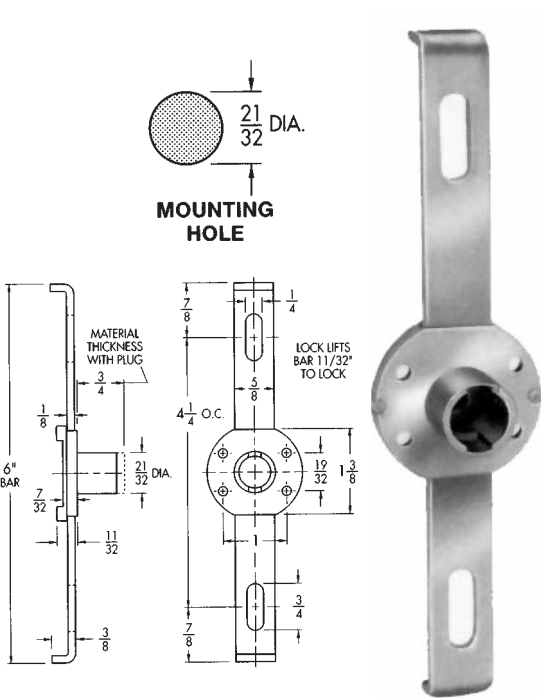

D8836 "Mini"

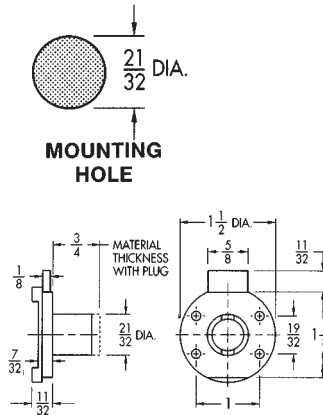

C8834
Drawer Lock



Use C8850 Core

APPLICATION — Two drawer "Mini Gang" lock for desk or pedestals, and single locking drawer for desk or pedestals. Surface Mounted.
OPERATION - Key turn on the D8836 moves the 6" bar from above or below the plastic stops, which are mounted on drawer sides, thus preventing drawer movement. C8834 has a 11/32" bolt throw.
KEYING — Order core plug separately, C8850.
PACKAGING — Housing assemblies supplied with four mounting screws and bolt. D8836 comes with two plastic stops and mounting screws. Housings are unplated.



Use C8850 Core

Part No.	Description	Type of Installation	Bar/Bolt Operation	Lock Cylinder Length	Bar/Bolt Travel	Case Quantity
C8834	Housing Assembly	Single Drawer	Dead	3/4"	11/32"	25
D8836	Housing Assembly	Desk Pedestals on two drawer applications	Dead Locking	3/4"	11/32"	10

DISC TUMBLER FURNITURE LOCKS

Gang Locks with: **REMOVACORE™**

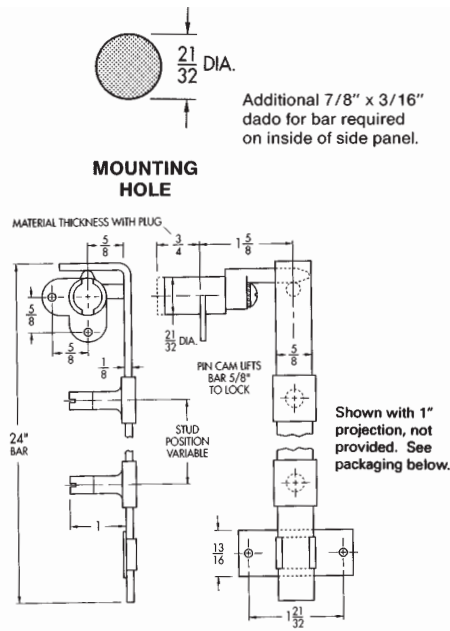

D8838 Front Mounted Gang Lock

APPLICATION — For locking drawers in desk pedestals and other multiple drawer applications. Lock mounts in right corner. Can also be mounted for left corner application. Surface mounted. Requires 21/32" dia. hole for cylinder, and when required, a dado for bar, measuring 7/8" x 3/16" deep in inside of panel.

OPERATION — Turning the key locks all drawers simultaneously (drawers must be in closed position). Bar moves studs from above or below the plastic stops, which are mounted on drawer sides, thus preventing drawer movement.

KEYING — Order core plug separately.

PACKAGING — Housing assembly supplied with three set screws for 1/2" projection, three slides, saddle, three plastic stops, and mounting screws. If 1" projection is required, order locking studs separately.

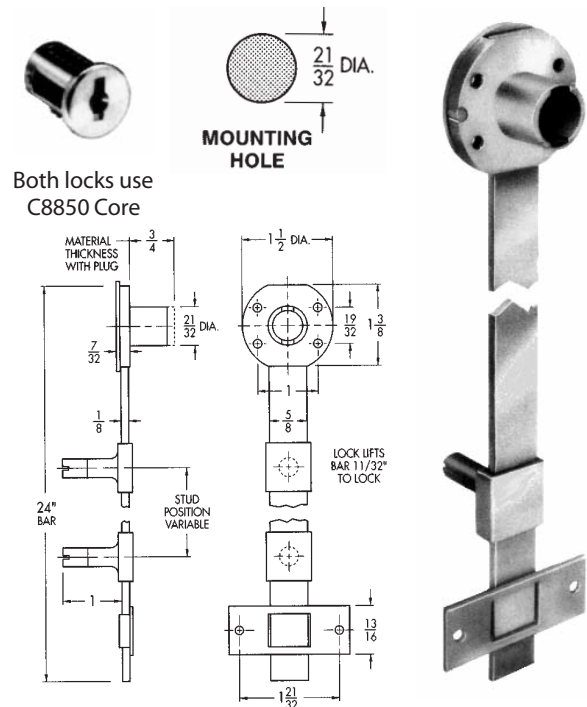

D8840 Side Mounted Gang Lock

APPLICATION — For locking drawers in desk pedestals and other multiple drawer applications. Lock mounts on inside of unit. Surface mounted. Requires 21/32" dia. hole for cylinder.

OPERATION — Turning the key locks all drawers simultaneously (drawers must be in closed position). Bar moves studs from above or below the plastic stops, which are mounted on drawer sides, thus preventing drawer movement.

KEYING — Order core plug separately, C8850.

PACKAGING — Housing assembly supplied with three set screws for 1/2" projection, three slides, saddle, three plastic stops, and mounting screws. If 1" projection is required, order locking studs separately.

Part No.	Description	Type of Installation	Bar Operation	Lock Cylinder Length	Bar Travel	Case Quantity
D8838	Housing Assembly	Desk Pedestal & Multi Drawer applications	Dead Locking	3/4"	5/8"	5
D8840	Housing Assembly		Dead Locking	3/4"	11/32"	5

Accessories

Part No.	Description	Dimensions	Material	Bag Quantity
C2018-19	Trim Ring	21/32" Dia.	Plastic	25
C7015-2C	5/16" Offset Cam	1-1/16 to hook	Steel	25
C7020-2C	Pin Cam	1"	Die Cast	25
C7021-2C	Pin Cam	1-1/2"	Die Cast	25
C7022-2C	Pin Cam	1-7/8"	Die Cast	25

Note: Order by number of pieces, not by bag. Full bags only. Orders must be in multiples of 25 pieces.



DISC TUMBLER CENTRAL LOCKING SYSTEMS

For convenience, we have gathered together in one package, all components, fasteners and installation guidelines to provide security for three typical wood office furniture applications.

Center Drawer Locking

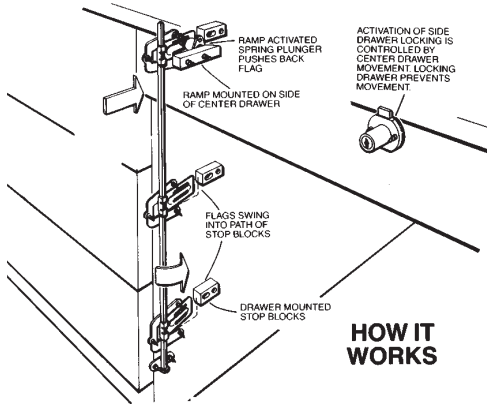

For simplification, only one pedestal application is shown.

APPLICATION — For installing in wood desks with center drawer and up to six side drawers, three per pedestal. Drawer lock is installed in center drawer.

OPERATION — Movement of the center drawer operates the system. When center drawer is closed, the closing motion is transferred to the pedestals via mounted ramps. Flags are pivoted into the path of side drawer mounted stops preventing opening of side drawers.

KEYING — Will key together with all other disc tumbler locks using D8785 key blank. See table for available keying. Masterkeying to E41A using D8783 key blank.

PACKAGING — Supplied with two keys and all components shown and necessary mounting screws. See installation sheet for complete parts listing.

Part. No.	Bolt Type	Cyl. Length	Bolt Throw	KA* Codes	KD Changes	Case Qty.	Non MK Key Blank
D8950-3	Dead	15/16"	11/32"	1	100	5	D8785
D8950-4G	Dead	15/16"	11/32"	1	100	5	D8785

Pedestal Locking

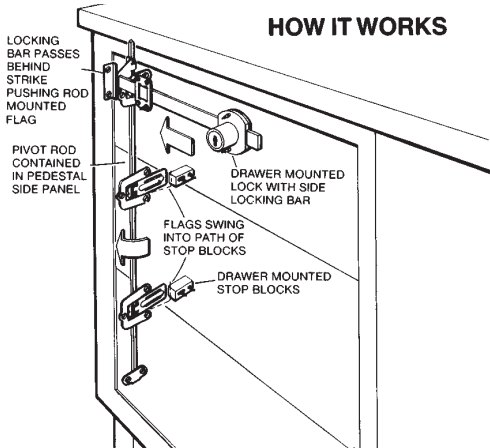

APPLICATION — For multiple drawer locking of wood desk pedestal only or mobile pedestal unit. Bar lock is installed in top drawer. For inside case width up to 15-1/2".

OPERATION — Locking the top drawer rotates rod with attached flags which pivot into path of drawer mounted stops preventing opening of lower drawers.

KEYING — Will key together with all other disc tumbler locks using D8785 key blank. See table for available keying. Masterkeying to E41A using D8783 key blank.

PACKAGING — Supplied with two keys and all components shown and necessary mounting screws. See installation sheet for complete parts listing.

Part. No.	Bar Operation	Cyl. Length	Bolt Throw	KA* Codes	KD Changes	Case Qty.	Non MK Key Blank
D8951-3	Reversible	15/16"	11/32"	1	100	5	D8785
D8951-4G	Reversible	15/16"	11/32"	1	100	5	D8785

Lateral File Locking

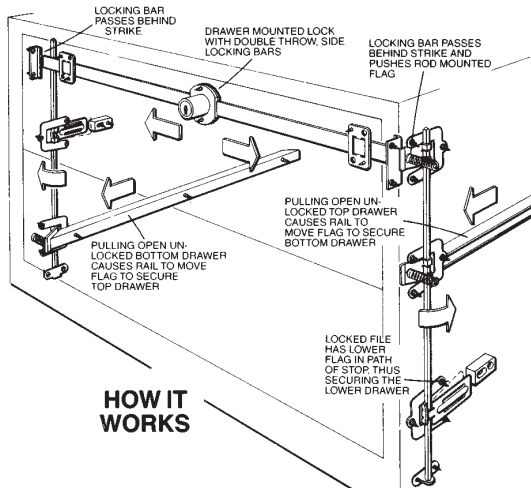

APPLICATION — For wood constructed two drawer lateral files with inside case width up to 42". Double throw bar is installed in top drawer.

OPERATION — Lateral files require "anti-tilt" performance of the hardware for safe operation. This permits only one drawer at a time to be opened. Opening a drawer results in a side mounted rail rotating the adjacent rod. Attached flag swings into path of stop mounted on other drawer preventing its opening. Locking the top drawer produces the same "lock-up" described above.

KEYING — Will key together with all other disc tumbler locks using D8785 key blank. See table for available keying. Masterkeying to E41A using D8783 key blank.

PACKAGING — Supplied with two keys and all components shown and necessary mounting screws. See installation sheet for complete parts listing.

Part. No.	Bar Operation	Cyl. Length	Bolt Throw	KA* Codes	KD Changes	Case Qty.	Non MK Key Blank
D8952-3	Double	15/16"	11/32"	1	100	5	D8785
D8952-4G	throw	15/16"	11/32"	1	100	5	D8785

*Keying Code used: 1 Code — C415A.

FURNITURE LOCKS

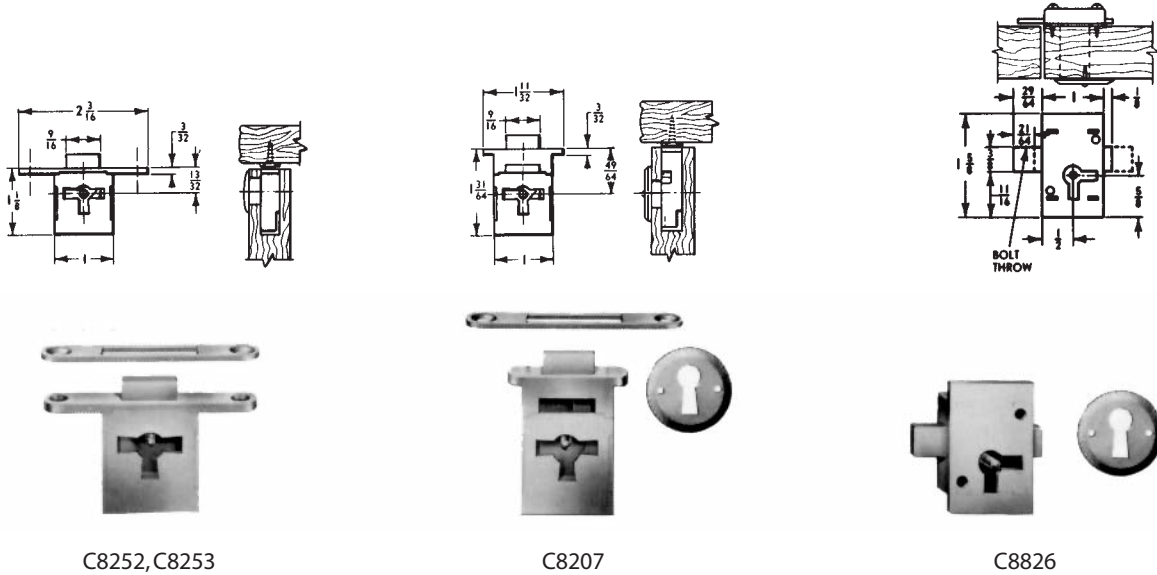

C8252, C8253

C8207

C8826

APPLICATION — This group of locks is used primarily on furniture and other fine cabinetry. C8826 is surface mounted and requires hole for key entry, all other locks require full 1 1/32" x depth of lock. Additional mortising, required for lock selvedge plus hole for key entry.

OPERATION — Key removable in both locked and unlocked positions.

KEYING — Each lock furnished keyed alike.

PACKAGING — Supplied with one key. All locks except C8826 are supplied with strikes. Key hole escutcheons are packed with C8207 and C8826

Part No.	Installation	Bolt Type	Bolt Travel	Case Quantity	Reference Number	Key Blank
C8207-3	R.H. Door, Drawer, Full Mortise	Dead	3/16"	25	N0-0274-001	D8890
C8252-3	L.H. Door, Full Mortise	Dead	3/16"	25	N0-0252-001	D8890
C8253-3	L.H. Door, Full Mortise	Dead	3/16"	25	N0-0252-002	D8890
C8826-3	Door/Drawer, Surface Mounted	Dead	21/64"	25	N0-0826-001	D8890

CHEST/LID LOCKS

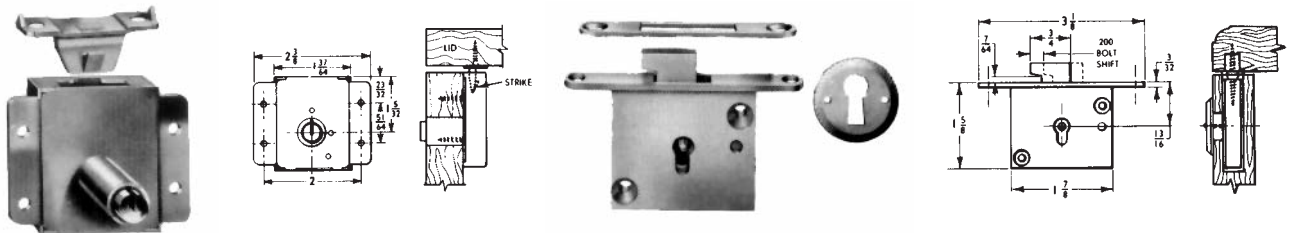

C8414
(Replaces C8412)

C8384

APPLICATION — Lid locks for cedar chest application and other lid locking requirements. C8412 is surface mounted and requires a 9/16" dia. hole for cylinder. C8384 requires 1 1/32" wide x depth of lock full mortise plus mortise for selvedge plus hole for key entry.

OPERATION — Key removable in both locked and unlocked positions. C8412 uses pushbutton to release lid when lock is used as a latch to keep lid closed, but not locked.

KEYING — Each lock furnished keyed alike.

PACKAGING — Supplied with one key. Appropriate strikes and mounting screws supplied with locks with additional keyhole escutcheon furnished with C8384.

Part No.	Installations	Bolt Type	Cylinder Length	Bolt Travel	Case Quantity	Reference Number	Key Blank
C8384-3	Chest Lid, Full Mortise	Hook	—	5/16" .200" side shift	25	N0-0384-001	D8890
C8414-4G	Chest Lid, Surface Mounted	Internal, Engages Strike	7/8"	—	25	N0-8414-001	D8194

DISC TUMBLER HANDLE LOCKS

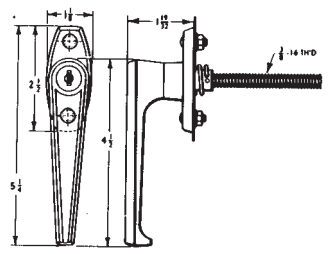
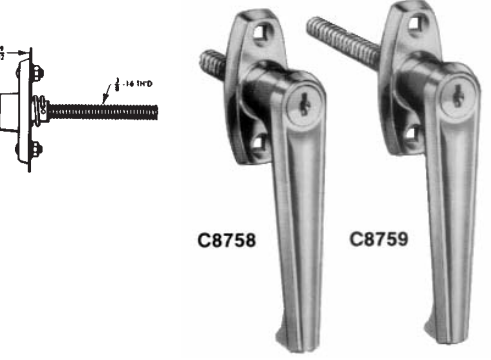
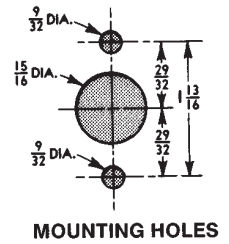
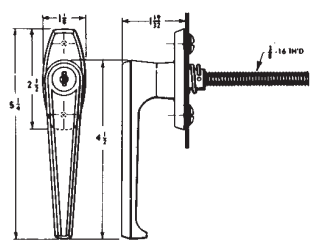
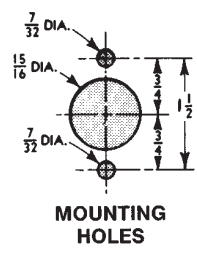
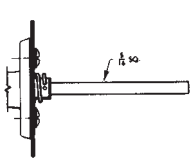
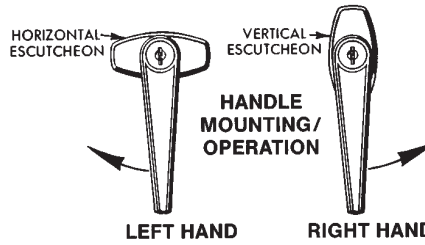

APPLICATION — For doors on metal lockers and cabinets. For R.H. doors, install with escutcheon vertical. For L.H. doors, install with escutcheon horizontal. See above drawings. Choice of spindle lengths and mounting. Spindles accept both C8756 latch plate and C8757 tongue except C8747 which has 8-32 tapped end hole and C8749 which will accept only the C8757 tongue. Spindles can be cut to fit special requirements.

OPERATION — Key removable in both locked and unlocked positions.

KEYING — Will key together with all other disc tumbler locks using D8785 key blank. See table for available keying.

PACKAGING — Supplied with two keys (except C8755) and mounting hardware.

Part No.	Type of Mounting	Spindle Length	Direction of Turn to Open	KA* Codes	Key Changes KD	Case Qty	Reference Number	Non MK Key Blank
C8747-26D	Rear	1" **	90° c/cw	1	200	10	M4-0428-420	D8785
C8749-26D	Rear	4" †	90° c/cw	1	200	10	M4-0428-293	D8785
C8751-26D	Rear	1"	90° c/cw	3	200	10	M4-0428-620	D8785
C8754-26D	Rear	3"	90° c/cw	3	200	10	M4-0428-684	D8785
C8755-26D††	Rear	3"	90° c/cw	—	—	10	M6-0429-684	—
C8758-26D	Thru-the Escutcheon	1"	90° c/cw	3	200	10	M4-0294-620	D8785
C8759-26D	Thru-the Escutcheon	3"	90° c/cw	3	200	10	M4-0294-684	D8785

*Key Codes used: 1 Code — C415A. 3 Codes — C413A, C415 and C420A.
†5/16" sq. spindle ††Non-Locking Handle.
**5/16" sq. spindle w/8-32 tapped end hole.

Latch Plate & Tongue for above Handle Locks

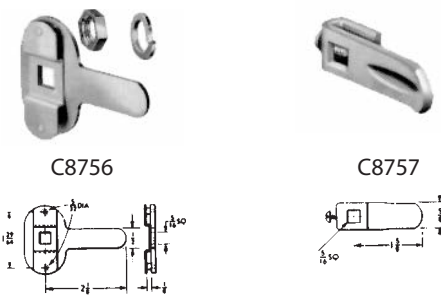

Part No.	Description	Method of Attachment to Spindle	Case Quantity	Reference Number
C8756-2C	3 Point Latch Plate with Tongue, Used with Locking Bars	Hex Nuts with Lock Washers Threaded on Spindle	25	M3-6931-001
C8757-2C	Single Point Latch Tongue	Side Mounted Set Screw	25	H2-0082-003

DISC TUMBLER CIRCUIT BREAKER CABINET LOCKS

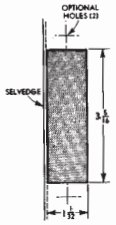

MOUNTING HOLE



C8070

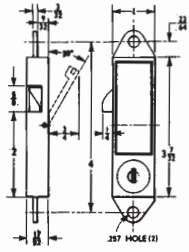

APPLICATION — For right handed metal doors of electrical circuit breaker cabinets.

OPERATION — Key removable in both locked and unlocked positions. Push plate operates spring bolt. Unlocked, push plate acts as spring latch.

KEYING — Supplied keyed alike only to B135A.

PACKAGING — Supplied with two keys; no mounting hardware.

Part No.	Type of Mounting	Bolt Type	Bolt Travel	Case Quantity	Reference Number	Key Blank
C8070-2C*	R.H. Door	Spring Pivot	7/32"	10	M4-0226-001	D8786

*Aluminum Enamel Finish.

GARAGE DOOR MECHANISM-LOCKING HANDLE

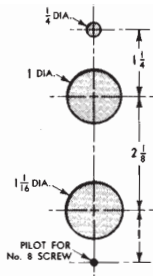

MOUNTING HOLES FOR HANDLE

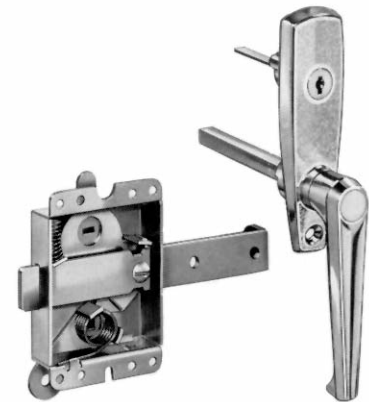
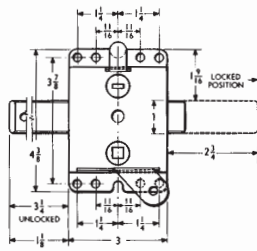
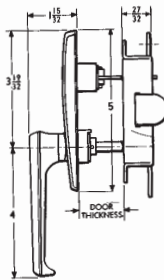

C8797

C8798

APPLICATION — For mounting on sectional overhead doors. Factory assembled for R.H. mounting. Mechanism installs at right side of door (inside garage) to lock into track. Handle can replace Overhead Door locking handles. Mechanism can be reversed for L.H. application.

OPERATION — Turning key releases mechanism, unlocking door. Handle turns down to vertical

position. Turn handle to horizontal to lock door. Key removable in both locked and unlocked positions.

KEYING — Available keyed differently only (10 changes).

PACKAGING — C8797 furnished with mounting screws. C8798 supplied with two keys and mounting screws.

Part No.	Installation	Operation	Key Changes KD	Case Quantity	Reference Number	Key Blank
C8797-2C	Inside door near track	Sliding bolt locks into track	—	5	M6-0492-001	—
C8798-26	Outside door over mechanism	Key releases bolt, Handle locks bolt	10	5	M4-0498-001	D8785

COOLER LOCKING HANDLE & REPLACEMENT PLUGS



C8765

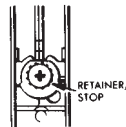
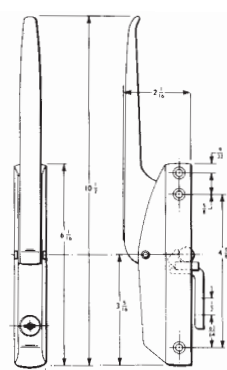

C8764

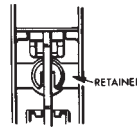

C8762

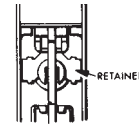

C8763



APPLICATION — Handle mounts on edge of freezer and cooler doors. Reversible for R.H. or L.H. doors. C8762 and C8763 replacement plugs are for earlier models of C8765 locking handles (National Lock 59-1105 series of handles).

OPERATION — Key removable in both locked and unlocked positions. Handle can be used as latch until locked with key.

KEYING — Keyed alike to XC-3.

PACKAGING — C8765 supplied with two keys, strike mounting plate and strike. Mounting screws not furnished. C8762 and C8763 plugs supplied with two keys and specific retainer. C8764 plug supplied with two keys, retainer/stop and screw.

Part No.	Installation	Bolt Type	Case Quantity	Key Blank
C8765-26	Edge mounted on Freezer/ Cooler Door	Integral Roller Bolt	5	D8780
C8764-26	Current C8765 Handles	—	25	D8780
C8763-26	N.L. 59-1105 Handles	—	25	D8780
C8762-26	Early models, N.L. 59-1105 Handles	—	25	D8780

LEVER TUMBLER DOOR LOCK

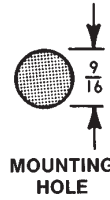
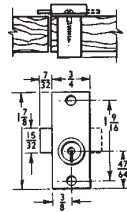

KEYING — Each lock furnished keyed alike.
PACKAGING — Supplied with strike (except C8422), mounting screws and two keys.

Part No.	Installation	Bolt Type	Cylinder Length	Bolt Travel	Case Quantity	Reference Number	Key Blank
C8422-3	Door	Dead	7/8"	7/32"	25	N0-2422-097	—

STRIKES, ESCUTCHEON, FLAT WASHER

Strikes are offered in two finishes. They are furnished with screws finished to match the strike.

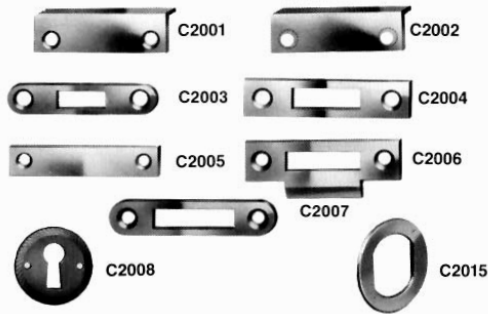

Ornamental escutcheon for furniture. Supplied with mounting pins.

Flat washer used to convert 3/4" dia. holes in steel fronts to a double "D" hole for installing cam locks. Spot weld to backside of hole.



7/8" dia. trim ring to be used to cover ragged edges around bored mounting holes.

C2017



C2016

Mounting plate for cylinder cam locks, screw mounted. Used where spur washer will not embed into hard surface. Packed 25 pcs. per bag

Part No.	Description	Overall Dimensions	Qty Per Bag
NAL C2001-14A	Formed strike, no bolt hole	1-3/4" x 1/2" with 3/16" form	25
NAL C2001-3			25
NAL C2002-14A	Formed strike, no bolt hole countersunk holes reversed	1-3/4" x 1/2" with 3/16" form	25
NAL C2002-3			25
NAL C2003-14A	Flat strike with rounded ends, 3/4" x 7/32" bolt hole	1-15/16" x 3/8"	25
NAL C2003-3			25
NAL C2004-14A	Flat strike with square ends, 7/8" x 17/64" bolt hole	2-5/32" x 1/2"	25
NAL C2004-3			25
NAL C2005-14A	Flat strike, no bolt hole	1-15/16" x 3/8"	25
NAL C2005-3			25
NAL C2006-14A	Flat strike with sq. ends and 15/16" x 1/4" tongue, 15/16" x 1/4" hole	2" x 3/4"	25
NAL C2006-3			25
NAL C2007-14A	Flat strike with rounded ends, 1-1/16" x 17/64" bolt hole	2-5/32" x 1/2"	25
NAL C2007-3			25
NAL C2008-3	Key hole escutcheon	1" Dia.	50
NAL C2015-2C	Flat washer for cam locks	1-1/8" Dia.	25
NAL C2016-2C	Mounting plate for cam locks Screw mounted, use No. 8 screws, not furnished.	2-3/16" x 1-1/4"	25
NAL C2017-14A	Trim ring for all locks with a 7/8" mounting hole.	7/8" Dia.	25
NAL C2017-26D			25
NAL C2017-3			25
NAL C2017-4			25
NAL C2017-4G			25

Note: Order by number of pieces, not by bag. Full bags only. Orders must be in multiples of 25 or 50 pieces.

DISC TUMBLER CAMS

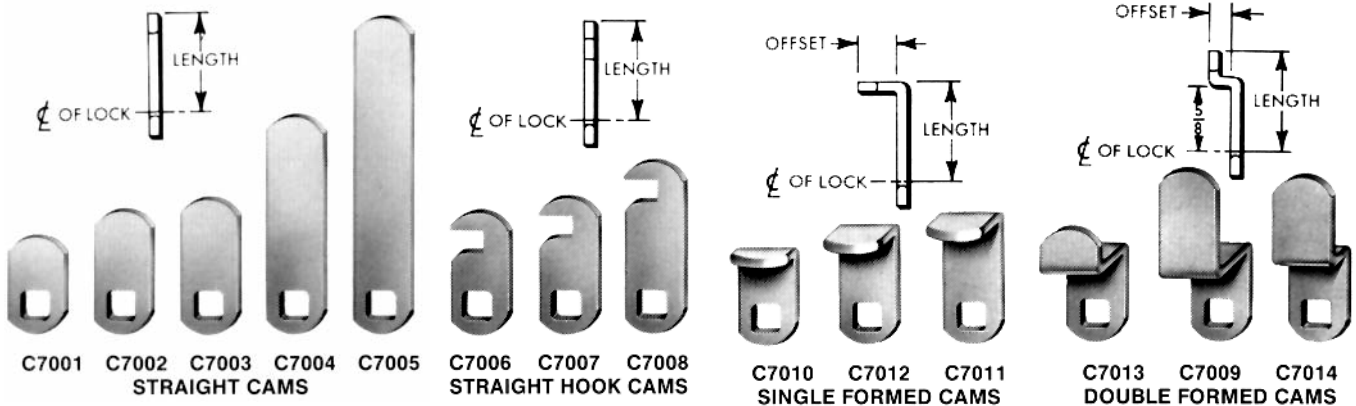

Selection of cams that permit adaption of disc tumbler cylinder cam locks to meet nearly every application need.

Straight Hook Cams and Double Formed Cams can be reversed when required.

Part No.	Description	Length	Qty Per Bag	Part No.	Description	Length	Offset	Qty Per Bag
C7001-2C	Straight Cam	3/4"	25	C7008-2C	Straight Hook Cam	1-1/2"	—	25
C7002-2C	Straight Cam	1"	25	C7009-2C	Double Formed Cam	1-3/4"	1/2"	25
C7003-2C	Straight Cam	1-1/8"	25	C7010-2C	Single Formed Cam	5/8"	7/32"	25
C7004-2C	Straight Cam	2"	25	C7011-2C	Single Formed Cam	1-1/8"	7/16"	25
C7005-2C	Straight Cam	3"	25	C7012-2C	Single Formed Cam	1"	7/16"	25
C7006-2C	Straight Hook Cam	1"	25	C7013-2C	Double Formed Cam	1-1/8"	3/8"	25
C7007-2C	Straight Hook Cam	1-1/8"	25	C7014-2C	Double Formed Cam*	1-5/8"	5/16"	25

*For overlay construction using 3/4" thick front and 3/4" thick frame material. Use with C8053 disc tumbler lock.

PIN TUMBLER CAMS

Double Formed Cams

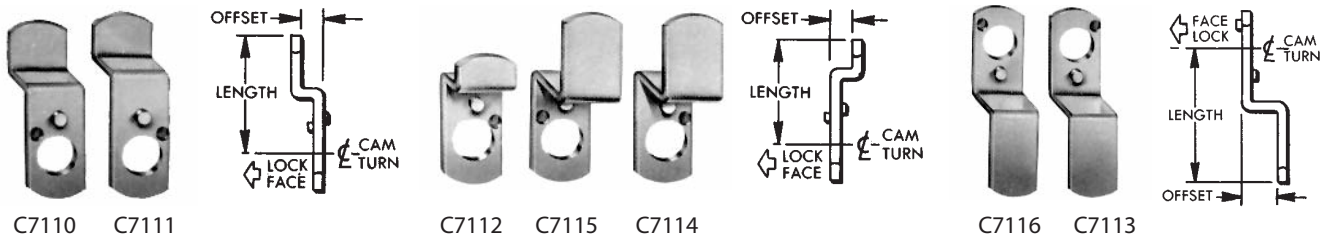

Cams for pin tumbler cylinder cam locks. All cams have dual function. See "Applications" column in table for details.

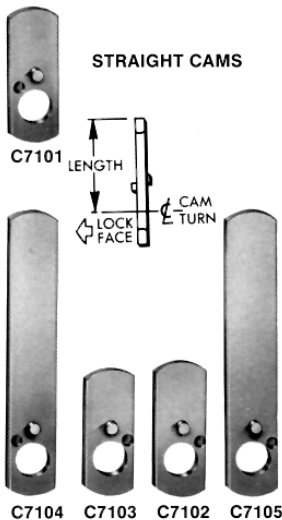

Applications Solid lines show locked position of cam	Position of shifter on back of lock	Part No.	Description	Length	Offset	Qty Per Bag
		C7101-2C	Straight Cam	1-1/4"	—	20
		C7104-2C	Straight Cam	3"	—	20
		C7110-2C	Double Formed Cam	1-1/4"	9/32"	20
		C7115-2C	Double Formed Cam*	1-5/8"	7/16"	20
		C7102-2C	Straight Cam	1-1/4"	—	20
		C7103-2C	Straight Cam	1-1/8"	—	20
		C7105-2C	Straight Cam	3"	—	20
		C7111-2C	Double Formed Cam	1-1/4"	9/32"	20
		C7112-2C	Double Formed Cam	1-1/8"	1/4"	20
		C7114-2C	Double Formed Cam*	1-5/8"	7/16"	20
		C7113-2C	Double Formed Cam*	1-5/8"	7/16"	20
		C7116-2C	Double Formed Cam*	1-5/8"	7/16"	20

*For overlay construction using 3/4" thick front and 3/4" thick frame material. Use with either C8102 or C8112 pin tumbler locks.

ORIGINAL PIN TUMBLER KEY BLANKS

Identifying Key Blanks

Blanks are listed with related actual size cross section.



Sight down the end of the blank to identify the cross section or profile.

Pin Tumbler Blanks



- 3 Pin Tumbler D4290
- 4 Pin Tumbler D4291
- 5 Pin Tumbler D4292
- 5 Pin Tumbler D4293

4 Pin Tumbler Blanks



D4296



D4297

5 Pin Tumbler Blank



D4295

Part No.	Description	Material	Carton Quantity	Reference Number
D4223	7 Pin Tumbler (tubular)	Steel	50	P9-6623-052
D4290	3 Pin Tumbler	Brass	50	M3-0679-111
D4291	4 Pin Tumbler	Brass	50	M3-0558-111
D4292	5 Pin Tumbler	Brass	50	M3-0676-111
D4293	5 Pin Tumbler	Brass	50	M3-0676-211
D4295	5 Pin Tumbler	Brass	50	M3-0600-111
D4296	4 Pin Tumbler (short)	Brass	50	M3-5655-111
D4297	4 Pin Tumbler (long)	Brass	50	M3-5450-212

Tubular Key Blank



D4223

ORIGINAL DISC TUMBLER KEY BLANKS

4 Disc Tumbler Blanks



- D8780 D
- D8781 E
- D8782 C
- D8790 R

5 Disc Tumbler Blanks



- D8783 F
- D8784 E
- D8785 C
- D8786 B
- D8791 R
- D8792 N
- D8793 M
- D8794 K

6 Disc Tumbler



- D8787 D
- D8788 E
- D8789 C
- D8795 N
- D8796 M
- D8798 K

5 or 6 Disc Tumbler Reversible Key Blanks



D8777



D8778



D8776

Part No.	Description	Material	Carton Quantity	Reference Number
D8776	5 Disc Tumbler Pass Key	Brass	50	P5-6613-301
D8777	5 or 6 Disc Tumbler Pass Key	Brass	50	M5-0650-111
D8778	5 or 6 Disc Tumbler Pass Key	Brass	50	M5-0650-906
D8780	4 Disc Tumbler Pass Key	Brass	50	M5-0682-111
D8781	4 Disc Tumbler Master Key	Brass	50	M5-0682-112
D8782	4 Disc Tumbler Pass Key	Brass	50	M5-0688-111
D8790	4 Disc Tumbler Pass Key	Brass	50	M5-0693-111
D8783	5 Disc Tumbler Pass Key	Brass	50	M5-0680-111
D8784	5 Disc Tumbler Master Key	Brass	50	M5-0680-112
D8785	5 Disc Tumbler Pass Key	Brass	50	M5-0687-111
D8786	5 Disc Tumbler Pass Key	Brass	50	M5-0691-111
D8787	6 Disc Tumbler Pass Key	Brass	50	M5-0694-117
D8788	6 Disc Tumbler Master Key	Brass	50	M5-0694-119
D8789	6 Disc Tumbler Pass Key	Brass	50	M5-0694-115
D8791	5 Disc Tumbler Pass Key	Brass	50	M5-0692-111
D8792	5 Disc Tumbler Pass Key	Brass	50	M5-0695-114
D8793	5 Disc Tumbler Pass Key	Brass	50	M5-0695-112
D8794	5 Disc Tumbler Master Key	Brass	50	M5-0695-113
D8795	6 Disc Tumbler Pass Key	Brass	50	M5-0694-113
D8796	6 Disc Tumbler Pass Key	Brass	50	M5-0694-112
D8798	6 Disc Tumbler Master Key	Brass	50	M5-0694-114

All Disc Tumbler Key Blanks, D8780 through D8798, are stamped with last two digits of part number to aid in identification. Example: D8788 is stamped "88".

ORIGINAL LEVER TUMBLER KEY BLANKS

Flat Lever Tumbler Blanks

Paracentric Lever Tumbler Blanks



Part No.	Description	Material	Carton Quantity	Reference Number
D8194	Lever Tumbler (cut) - Flat	Steel	50	N1-8414-105
D8192	Lever Tumbler Blank - Flat	Steel	50	N1-0651-101
D8193	Lever Tumbler Blank - Flat	Steel	50	N1-0656-113
D8490	Lever Tumbler Blank - Paracentric	Brass	50	N1-0681-111
D8491	Lever Tumbler Blank - Paracentric	Brass	50	N1-0640-119

ORIGINAL MASTERKEYS

KEY CODE BOOKS



Part No.	Description	Material	Reference Number
D4299	Pin Tumbler GM1 Masterkey	Brass	M3-0686-399
D8419	Lever Tumbler 5LM Flat Masterkey	Steel	N1-0651-399
D8799	Disc Tumbler E41A Masterkey	Brass	M5-0680-399
D8999	Disc Tumbler E13A Masterkey	Brass	M5-0680-399

D8001 Pin Tumbler Key Codes — Includes the most popular National key codes: GM1 series, GM2 series, GM2A series, GM300 series, GM600 series and GM700 series.



D8001

D8002

D8002 Disc Tumbler and Lever Tumbler Key Codes — Includes the most popular National key codes: standard 4 tumbler series, standard 5 tumbler series, standard 6 tumbler series 5 tumbler prefix RD series, 5 tumbler prefix GF series, 5 tumbler prefix SK and KS series, 6 tumbler prefix SK and KS series and 5 lever tumbler series 8LLT.

KEYS

Freezer Lock Keys

Warded Barrel Key



Part No.	Description	Material	Carton Quantity	Reference Number
D8590	Freezer Lock Key Wrench - Cross Shape	Die Cast	50	N5-0811-001
D8591	Freezer Lock Key Wrench - Pentagon Shape	Die Cast	50	N5-0812-001
D8890	Warded Barrel Key	Die Cast	50	M5-0689-102

KEYING KITS



V70P-1



V70P-2

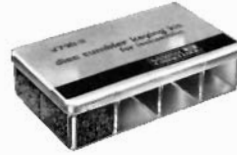

V71D-3

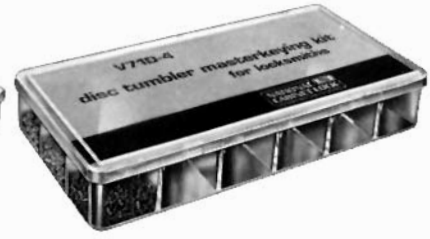

V71D-4

V70P-1 Pin Tumbler Keying Kit — Includes:
 100 Pcs. ea. 1, 2, 3 and 4 Drivers.
 100 Pcs. ea. 0, 1, 2, 3, 4, 5, 6, 7, 8 and 9 Tumblers.
 250 Pcs. Tumbler Springs
 100 Pcs. Tumbler Retainers
 50 Pcs. ea. C3735 and C3738 Plug Retainers.

V70P-2 Pin Tumbler Masterkeying Kit — Includes:
 100 Pcs. ea. 2, 3, 4, 5, 6, 7, 8 and 9 Master Drivers.

V71D-3 Disc Tumbler Keying Kit — Includes:
 100 Pcs. ea. 00, 22, 44 and 66 Tumblers.
 250 Pcs. Tumbler Springs.

V71D-4 Disc Tumbler Masterkeying Kit — Includes:
 100 Pcs. ea. 02, 04, 06, 20, 24, 26, 40, 42, 46, 60, 62 and 64 Tumblers.
 250 Pcs. Tumbler Springs.

KEYING KIT REPLACEMENT PARTS

Pin Tumbler Keying Kit Replacement Parts

Disc Tumbler Keying Kit Replacement Parts



C3740- C3747
 C3730- C3733
 C3750- C3759
 C3734

C3735
 C3736
 C3737
 C3738

D6676
 D6686



C6782- C6797
 C6798

D6680
 D6682

Part No.	Description	Identifying Color	Qty Per Bag	Part No.	Description	Qty Per Bag
C3730	#1 Driver	Blue	250	D6676	5 Pin Tumbler Depth Keys — Set of 10 Keys	1 Set
C3731	#2 Driver	Slate Gray	250	D6680	5 Disc Tumbler Depth Keys — Set of 4 Keys	1 Set
C3732	#3 Driver	Copper	250	D6682	4 Disc Tumbler Depth Keys — Set of 4 Keys	1 Set
C3733	#4 Driver	Violet	250	D6686	4 Pin Tumbler Depth Keys — Set of 10 Keys	1 Set
C3734	Plug Retainer	—	100	C6782	#00 Tumbler	250
C3735	Plug Retainer	—	100	C6783	#22 Tumbler	250
C3736	Tumbler Retainer	—	100	C6784	#44 Tumbler	250
C3737	Tumbler Spring	—	500	C6785	#66 Tumbler	250
C3738	Plug Retainer	—	100	C6786	#02 Tumbler	250
C3740	#2 Master Driver	Violet	250	C6787	#04 Tumbler	250
C3741	#3 Master Driver	Red	250	C6788	#06 Tumbler	250
C3742	#4 Master Driver	Blue	250	C6789	#20 Tumbler	250
C3743	#5 Master Driver	Fuchsia	250	C6790	#24 Tumbler	250
C3744	#6 Master Driver	Slate Gray	250	C6791	#26 Tumbler	250
C3745	#7 Master Driver	Brass	250	C6792	#40 Tumbler	250
C3746	#8 Master Driver	Copper	250	C6793	#42 Tumbler	250
C3747	#9 Master Driver	Brown	250	C6794	#46 Tumbler	250
C3750	#0 Tumbler	Silver	250	C6795	#60 Tumbler	250
C3751	#1 Tumbler	Black	250	C6796	#62 Tumbler	250
C3752	#2 Tumbler	Violet	250	C6797	#64 Tumbler	250
C3753	#3 Tumbler	Red	250	C6798	Tumbler Spring	500
C3754	#4 Tumbler	Blue	250			
C3755	#5 Tumbler	Fuchsia	250			
C3756	#6 Tumbler	Slate Gray	250			
C3757	#7 Tumbler	Brass	250			
C3758	#8 Tumbler	Copper	250			
C3759	#9 Tumbler	Brown	250			