

CLASSIC WRAP-AROUNDS

All Classic Wrap-Arounds Feature...

- Built-in stainless steel threaded insert
- Long lasting and secure mounting of latch and bolt
- Improved heavy duty stainless steel trim screws
- Permanent holding power eliminates loosening of latch screws
- Assorted backsets available
- STRIKE NOT INCLUDED

CW = BOX

Shelfpack is one

For Cylindrical Door Locks with 2 1/8" Hole

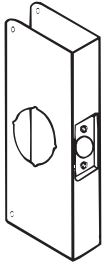

Part No.	Finish	Door Backset	Thickness	Unit Dim.
DON 1-AB-CW	Antique Brass	2 3/8"	1 3/8"	4 x 9"
DON 1-PB-CW	Polished Brass	2 3/8"	1 3/8"	4 x 9"
DON 1-S-CW	Stainless Steel	2 3/8"	1 3/8"	4 x 9"
DON 2-10B-CW	Oxidized Bronze	2 3/8"	1 3/4"	4 x 9"
DON 2-AB-CW	Antique Brass	2 3/8"	1 3/4"	4 x 9"
DON 2-BZ-CW	Satin Bronze	2 3/8"	1 3/4"	4 x 9"
DON 2-PB-CW	Polished Brass	2 3/8"	1 3/4"	4 x 9"
DON 2-S-CW	Stainless Steel	2 3/8"	1 3/4"	4 x 9"
DON 3-AB-CW	Antique Brass	2 3/4"	1 3/8"	4 1/4 x 9"
DON 3-PB-CW	Polished Brass	2 3/4"	1 3/8"	4 1/4 x 9"
DON 3-S-CW	Stainless Steel	2 3/4"	1 3/8"	4 1/4 x 9"
DON 4-10B-CW	Oxidized Bronze	2 3/4"	1 3/4"	4 1/4 x 9"
DON 4-BZ-CW	Satin Bronze	2 3/4"	1 3/4"	4 1/4 x 9"
DON 4-PB-CW	Polished Brass	2 3/4"	1 3/4"	4 1/4 x 9"
DON 4-S-CW	Stainless Steel	2 3/4"	1 3/4"	4 1/4 x 9"

For Cylindrical Door Locks with 2 1/8" Hole

For Use with Grade 1 and Grade 2 Key-In-Levers

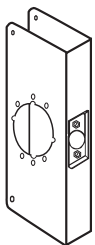

- Unit Dimension: 4 3/4 x 9"

Part No.	Finish	Door Backset	Thickness
DON 4-10B-2-CW	Oxy. Bronze	2 3/4"	1 3/4"

For Deadbolts with 1 1/2" Hole

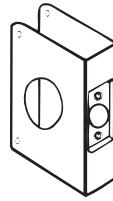

Part No.	Finish	Backset	Door Thickness	Unit Dim.
DON 5-AB-CW	Antique Brass	2 3/8"	1 3/8"	4 x 4 1/2"
DON 5-PB-CW	Polished Brass	2 3/8"	1 3/8"	4 x 4 1/2"
DON 5-S-CW	Stainless Steel	2 3/8"	1 3/8"	4 x 4 1/2"
DON 6-S-CW	Stainless Steel	2 3/8"	1 3/4"	4 x 4 1/2"
DON 7-AB-CW*	Antique Brass	2 3/4"	1 3/8"	4 1/4 x 4 1/2"
DON 7-BZ-CW	Satin Bronze	2 3/4"	1 3/8"	4 1/4 x 4 1/2"
DON 7-PB-CW*	Polished Brass	2 3/4"	1 3/8"	4 1/4 x 4 1/2"
DON 7-S-CW	Stainless Steel	2 3/4"	1 3/8"	4 1/4 x 4 1/2"
DON 8-AB-CW*	Antique Brass	2 3/4"	1 3/4"	4 1/4 x 4 1/2"
DON 8-BZ-CW*	Satin Bronze	2 3/4"	1 3/4"	4 1/4 x 4 1/2"
DON 8-PB-CW*	Polished Brass	2 3/4"	1 3/4"	4 1/4 x 4 1/2"
DON 8-S-CW	Stainless Steel	2 3/4"	1 3/4"	4 1/4 x 4 1/2"

NOTE: Above sizes also available in 10B (Oil Rubbed Bronze) finish in display packaging only. *F/O

For Cylindrical Door Locks with 2 1/8" Hole, 12" Height

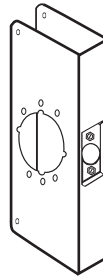

- Unit Dimension: 4 3/4 x 12"

Part No.	Finish	Backset	Door Thickness
DON 12-2-PB-CW	Pol. Brass	2 3/4"	1 3/4"
DON 12-2-S-CW	S. Steel	2 3/4"	1 3/4"

For Conversion of Simplex 1000 Series and Alarm Lock DL2500, 2700/T2 and 3000 Series

For Use with Grade 1 Lever Lock

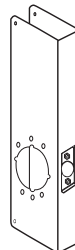

- Unit Dimension: 5 x 14"

Part No.	Finish	Backset	Door Thickness
DON 14-2-AB-CW	Antique Brass	2 3/4"	1 3/4"
DON 14-2-PB-CW	Pol. Brass	2 3/4"	1 3/4"
DON 14-2-S-CW	S. Steel	2 3/4"	1 3/4"

CLASSIC WRAP-AROUNDS

For Conversion of Simplex 1000 Series & Alarm Lock DL2500, 2700/T2 and 3000 Series to Key-In-Knob lock

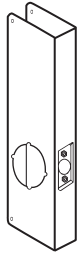

• Unit Dimension: 5 x 14"

Part No.	Finish	Backset	Door Thickness
DON 14-S-CW	S.Steel	2 ³ / ₄ "	1 ³ / ₄ "

Fits Schlage Cobra Locks

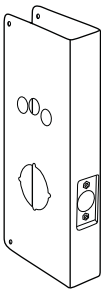

• Unit Dimension: 5 x 12"

Part No.	Finish	Backset	Door Thickness
DON 17-10B-CW	Ox. Bronze	2 ³ / ₄ "	1 ³ / ₄ "
DON 17-PB-CW	Pol. Brass	2 ³ / ₄ "	1 ³ / ₄ "
DON 17-S-CW	S. Steel	2 ³ / ₄ "	1 ³ / ₄ "

Fits Schlage Cobra Locks

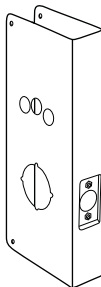

• Unit Dimension: 5 x 15"

Part No.	Finish	Backset	Door Thickness
DON 18-PB-CW	Pol. Brass	2 ³ / ₄ "	1 ³ / ₄ "
DON 18-S-CW	S. Steel	2 ³ / ₄ "	1 ³ / ₄ "
DON 18-10B-CW	Oil Rubd Brnz	2 ³ / ₄ "	1 ³ / ₄ "

20" Wrap-Around

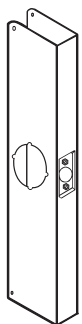

20-CW

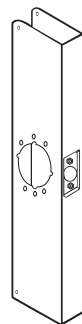

20-2-CW

- Unit Dimension: 5 x 20"
- Beveled front
- Non-Handed
- Box Packed Only, Shelf Pack: 1

Part No.	Finish	Backset	Door Thickness
DON 20-S-CW	S. Steel	2 ³ / ₄ "	1 ³ / ₄ "
DON 20-S-2-CW	S. Steel	2 ³ / ₄ "	1 ³ / ₄ "

For Cylindrical Door Locks with 2¹/₈" Hole

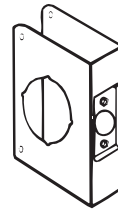

Part No.	Finish	Backset	Door Thickness	Unit Dim.
DON 51-AB-CW	Antique Brass	2 ³ / ₈ "	1 ³ / ₈ "	4 x 4 ¹ / ₂ "
DON 51-BZ-CW	Satin Bronze	2 ³ / ₈ "	1 ³ / ₈ "	4 x 4 ¹ / ₂ "
DON 51-PB-CW	Polished Brass	2 ³ / ₈ "	1 ³ / ₈ "	4 x 4 ¹ / ₂ "
DON 51-S-CW	Stainless Steel	2 ³ / ₈ "	1 ³ / ₈ "	4 x 4 ¹ / ₂ "
DON 61-AB-CW	Antique Brass	2 ³ / ₈ "	1 ³ / ₄ "	4 x 4 ¹ / ₂ "
DON 61-PB-CW	Polished Brass	2 ³ / ₈ "	1 ³ / ₄ "	4 x 4 ¹ / ₂ "
DON 61-S-CW	Stainless Steel	2 ³ / ₈ "	1 ³ / ₄ "	4 x 4 ¹ / ₂ "
DON 71-AB-CW*	Antique Brass	2 ³ / ₄ "	1 ³ / ₈ "	4 ¹ / ₄ x 4 ¹ / ₂ "
DON 71-BZ-CW*	Satin Bronze	2 ³ / ₄ "	1 ³ / ₈ "	4 ¹ / ₄ x 4 ¹ / ₂ "
DON 71-PB-CW	Polished Brass	2 ³ / ₄ "	1 ³ / ₈ "	4 ¹ / ₄ x 4 ¹ / ₂ "
DON 71-S-CW	Stainless Steel	2 ³ / ₄ "	1 ³ / ₈ "	4 ¹ / ₄ x 4 ¹ / ₂ "
DON 81-AB-CW	Antique Brass	2 ³ / ₄ "	1 ³ / ₄ "	4 ¹ / ₄ x 4 ¹ / ₂ "
DON 81-BZ-CW	Satin Bronze	2 ³ / ₄ "	1 ³ / ₄ "	4 ¹ / ₄ x 4 ¹ / ₂ "
DON 81-PB-CW	Polished Brass	2 ³ / ₄ "	1 ³ / ₄ "	4 ¹ / ₄ x 4 ¹ / ₂ "
DON 81-S-CW	Stainless Steel	2 ³ / ₄ "	1 ³ / ₄ "	4 ¹ / ₄ x 4 ¹ / ₂ "

NOTE: Above sizes also available in 10B (Oil Rubbed Bronze) finish in display packaging only.

*F/O

For Double Lock Combination Locksets with 1¹/₂" Hole on Top & 2¹/₈" Hole on Bottom with 4" Centers

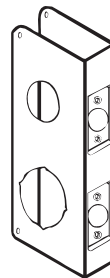

Part No.	Finish	Backset	Door Thickness	Unit Dim.
DON 264-PB-CW	Pol. Brs	2 ³ / ₈ "	1 ³ / ₄ "	4 x 9"
DON 264-S-CW	S. Steel	2 ³ / ₈ "	1 ³ / ₄ "	4 x 9"
DON 484-AB-CW	Antq Brs	2 ³ / ₄ "	1 ³ / ₄ "	4 ¹ / ₄ x 9"
DON 484-BZ-CW	Satin Brz	2 ³ / ₄ "	1 ³ / ₄ "	4 ¹ / ₄ x 9"
DON 484-PB-CW	Pol. Brs	2 ³ / ₄ "	1 ³ / ₄ "	4 ¹ / ₄ x 9"
DON 484-S-CW	S. Steel	2 ³ / ₄ "	1 ³ / ₄ "	4 ¹ / ₄ x 9"

Above sizes also available in 10B (Oil Rubbed Bronze) finish in display packaging

For Double Lock Combination Locksets with 2¹/₈" Holes with 3⁵/₈" Centers



Part No.	Finish	Backset	Door Thickness	Unit Dim.
DON 261-AB-CW	Antq Brs	2 ³ / ₈ "	1 ³ / ₄ "	4 x 9"
DON 261-BZ-CW	Satin Brz	2 ³ / ₈ "	1 ³ / ₄ "	4 x 9"
DON 261-PB-CW	Pol. Brs	2 ³ / ₈ "	1 ³ / ₄ "	4 x 9"
DON 261-S-CW	S. Steel	2 ³ / ₈ "	1 ³ / ₄ "	4 x 9"
DON 481-AB-CW	Antq Brs	2 ³ / ₄ "	1 ³ / ₄ "	4 ¹ / ₄ x 9"
DON 481-BZ-CW*	Satin Brz	2 ³ / ₄ "	1 ³ / ₄ "	4 ¹ / ₄ x 9"
DON 481-PB-CW	Pol. Brs	2 ³ / ₄ "	1 ³ / ₄ "	4 ¹ / ₄ x 9"
DON 481-S-CW	S. Steel	2 ³ / ₄ "	1 ³ / ₄ "	4 ¹ / ₄ x 9"

Above sizes also available in 10B (Oil Rubbed Bronze) finish in display packaging only. *F/O

For Double Lock Combination Locksets with 2 1/8" Holes with 4" Centers

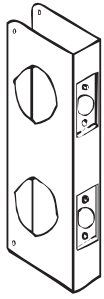

- Box size is 4 1/2 x 9 3/4"

Part No.	Finish	Backset	Door Thickness	Unit Dim.
DON 942-AB-CW*	Antq Brs	2 3/8"	1 3/4"	4 x 9"
DON 942-BZ-CW*	Satin Brz	2 3/8"	1 3/4"	4 x 9"
DON 942-PB-CW	Pol. Brs	2 3/8"	1 3/4"	4 x 9"
DON 942-S-CW*	S. Steel	2 3/8"	1 3/4"	4 x 9"
DON 943-AB-CW*	Antq Brs	2 3/4"	1 3/4"	4 1/4 x 9"
DON 943-BZ-CW*	Satin Brz	2 3/4"	1 3/4"	4 1/4 x 9"
DON 943-PB-CW*	Pol. Brs	2 3/4"	1 3/4"	4 1/4 x 9"
DON 943-S-CW*	S. Steel	2 3/4"	1 3/4"	4 1/4 x 9"

Above sizes also available in 10B (Oil Rubbed Bronze) finish in display packaging only. *F/O

For Simplex 5000 Lock

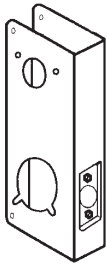

- Unit Dimension: 5 x 12"

Part No.	Finish	Backset	Door Thickness
DON 5000-S-CW	S. Steel	2 3/4"	1 3/4"

For Thicker Doors

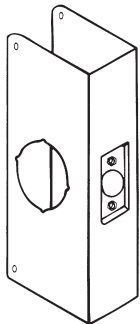

- Shelf Pack: 1
- Dimension: 4 1/4 x 9"

Part No.	Finish	Backset	Door Thickness
DON 200-S-CW	S. Steel	2 3/4"	2"
DON 200C-S-CW	S. Steel	2 3/8"	2"

Blank Wrap-Around with Trim Screw Holes

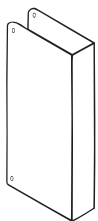

- Box sizes are 5 1/4 x 4 1/2" and 4 1/2 x 9 3/4"

Part No.	Finish	Door Thickness	Unit Dim.
DON 30-PB-CW	Pol. Brs	1 3/8"	4 1/4 x 9"
DON 30-S-CW	S. Steel	1 3/8"	4 1/4 x 9"
DON 40-PB-CW	Pol. Brs	1 3/4"	4 1/4 x 9"
DON 40-S-CW	S. Steel	1 3/4"	4 1/4 x 9"
DON 70-PB-CW	Pol. Brs	1 3/8"	4 1/4 x 4 1/2"
DON 70-S-CW	SS	1 3/8"	4 1/4 x 4 1/2"
DON 80-PB-CW	Pol. Brs	1 3/4"	4 1/4 x 4 1/2"
DON 80-S-CW	S. Steel	1 3/4"	4 1/4 x 4 1/2"

Above sizes also available in 10B (Oil Rubbed Bronze) finish in display packaging only.

Fits Simplex 1000 Series

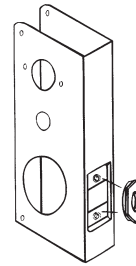

DON CW-9

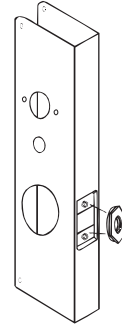

DON CW-15

Part No.	Finish	Backset	Door Thickness	Unit Dim.
DON 9-AB-CW	Antique Brass	2 3/4"	1 3/4"	5 x 9"
DON 9-S-CW	Stainless Steel	2 3/4"	1 3/4"	5 x 9"
DON 15-AB-CW	Antique Brass	2 3/4"	1 3/4"	5 x 15"
DON 15-PB-CW*	Polished Brass	2 3/4"	1 3/4"	5 x 15"
DON 15-S-CW	Stainless Steel	2 3/4"	1 3/4"	5 x 15"

*F/O

Fits Alarm Lock 2700/T2 and 3000 Series Trilogy

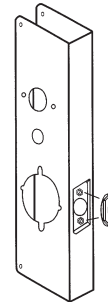

Part No.	Finish	Backset	Door Thickness	Unit Dim.
DON 27-AB-CW	Antique Brass	2 3/4"	1 3/4"	5 x 15"
DON 27-S-CW	Stainless Steel	2 3/4"	1 3/4"	5 x 15"

For Use with Heavy Duty Grades 1+2 Key-In-Levers

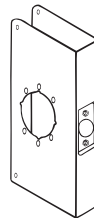

- Works with Schlage Rhodes, Arrow Sierra, Yale Augusta, Sargent 10-Line, Corbin Russwin CL3300/CL3600, Falcon T and B Series and Lori Retrofit Kit.

Part No.	Finish	Backset	Door Thickness	Unit Dim.
DON 4-BZ-2-CW*	Satin Bronze	2 3/4"	1 3/4"	4 3/4 x 9"
DON 4-PB-2-CW	Polished Brass	2 3/4"	1 3/4"	4 3/4 x 9"
DON 4-S-2-CW	Stainless Steel	2 3/4"	1 3/4"	4 3/4 x 9"

*F/O

CLASSIC WRAP-AROUNDS

For Locks with Extended Backsets

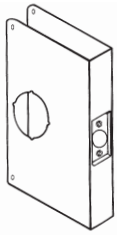

- Shelf Pack: 1

Part No.	Finish	Backset	Door Thickness	Unit Dim.
DON 55-PB-CW	Polished Brass	5"	1 ³ / ₄ "	6 ¹ / ₂ × 9"
DON 55-S-CW	Stainless Steel	5"	1 ³ / ₄ "	6 ¹ / ₂ × 9"

Mortise Lock Wrap-Around Plate for 86 Cut-Out

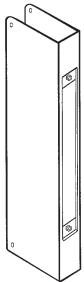

- 8 × 1¹/₄" recess
- Drill spindle and thumb turn holes in field

Part No.	Finish	Door Thickness	Unit Dim
DON 504-S-CW	Stainless Steel	1 ³ / ₄ "	5 × 12"

ELECTRONIC LOCK WRAP-AROUNDS

Works with Mas Hamilton Power Lever

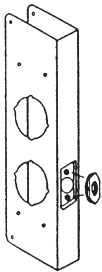

Part No.	Finish	Back set	Door Thickness	Unit Dim
DON 16-S-CW	S.Steel	2 ³ / ₄ "	1 ³ / ₄ "	5" × 15"

Works with Simplex 4000

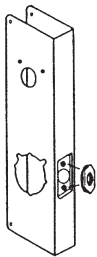

Part No.	Finish	Back set	Door Thickness	Unit Dim.
DON 4000-2-S-CW*	SS	2 ³ / ₈ "	1 ³ / ₄ "	5" × 15"
DON 4000-4-S-CW	SS	2 ³ / ₄ "	1 ³ / ₄ "	5" × 15"

*F/O

LATCH PROTECTORS

DON-JO MFG., INC. manufactures a complete line of Latch Protectors. They are available in a variety of styles for aluminum doors, outswinging doors and inswinging doors.

The Interlock, for Inswinging Doors

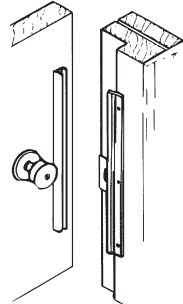

- 14 gauge (.075) steel
- 6" version for use with key-in-knob and deadbolt locks
- 12" version for use with Mortise Locks; Simplex 1000 Series; Alarm Lock DL-2500, DL-2700, 3000; Card Access Systems, etc.
- Shelf Pack: 10

Part No.	Finish	Unit Dim.	Display Pkg. Size
DON ILP-206-BP	Brass Plated	6"	4 × 12"
DON ILP-206-DU	Duro Coated	6"	4 × 12"
DON ILP-206-SL	Silver Coated	6"	4 × 12"
DON ILP-212-BP	Brass Plated	12"	4 × 16"
DON ILP-212-DU	Duro Coated	12"	4 × 16"
DON ILP-212-SL	Silver Coated	12"	4 × 16"

For Aluminum Entrance Doors

Solves Pull Handle Interference

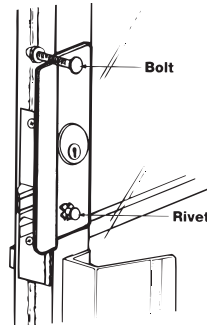

- 12 gauge (.104) steel
- Shelf Pack: 10
- Reversible
- Fits over cylinder — lock removal NOT required
- Hand carriage bolt and rivet supplied
- No specific tools required
- 3/8" offset

Part No.	Finish	Unit Dim.	Display Pkg. Size
DON LP-307-DU	Duro Coated	2 ⁵ / ₈ × 7 × 1/8"	4 × 12"
DON LP-307-SL	Silver Coated	2 ⁵ / ₈ × 7 × 1/8"	4 × 12"

LATCH PROTECTORS

For Aluminum Entrance Doors

Solves Pull Handle Interference

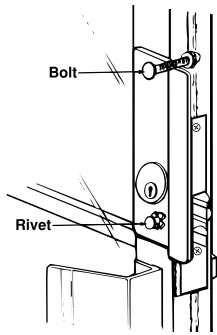

- 12 gauge (.104) steel
- Shelf Pack: 10
- Reversible
- Fits over cylinder — lock removal NOT required
- Hand carriage bolt and rivet supplied
- No specific tools required
- 3/8" offset
- Center of cylinder hole is 2 1/2" from end of plate

Part No.	Finish	Unit Dim.	Display Pkg. Size
DON GLP-307-SL-RHR*	Silver Coated	2 5/8 x 7 x 1/8"	4 x 12"
DON GLP-307-SL-LHR*	Silver Coated	2 5/8 x 7 x 1/8"	4 x 12"
DON GLP-307-DU-RHR*	Duro Coated	2 5/8 x 7 x 1/8"	4 x 12"
DON GLP-307-DU-LHR*	Duro Coated	2 5/8 x 7 x 1/8"	4 x 12"

*F/O

For Key-In-Lever Locks

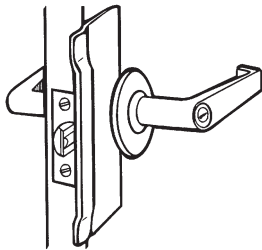

- 12 gauge (.104) steel
- Works with up to 3 3/4" rose
- Concealed welded studs with fasteners
- Polybagged
- Shelf Pack: 10

Part No.	Finish	Unit Dim.
DON BLP-107-630	Satin S.Steel	3 1/4 x 7"
DON BLP-207-DU	Duro Coated	3 1/4 x 7"
DON BLP-110-630	Satin S.Steel	3 1/4 x 10"
DON BLP-210-DU	Duro Coated	3 1/4 x 10"

America's Favorite for Outswinging Doors — Completely Covers the Strike Plate

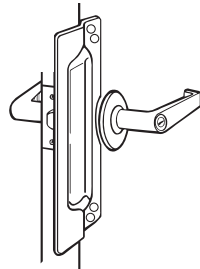

- 12 gauge (.104) steel
- Furnished with carriage bolts, washers & acorn cap nuts for safety and strength
- Shelf Pack: 10
- Display package size is 4 x 16"
- Fits 2 3/4" and 2 3/8" backsets

Part No.	Finish	Unit Dim.	Display Pkg. Size
DON LP-111-630	Stainless Steel	3 x 11"	4 x 16"
DON LP-211-BP	Brass Plated	3 x 11"	4 x 16"
DON LP-211-DU	Duro Coated	3 x 11"	4 x 16"
DON LP-211-PC	Prime Coated	3 x 11"	4 x 16"
DON LP-211-SL	Silver Coated	3 x 11"	4 x 16"

For Key-In-Knob Locksets on Outswinging Doors

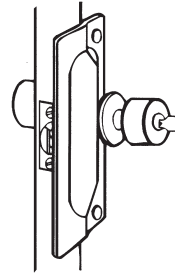

- 12 gauge (.104) steel
- Shelf Pack: 10
- Furnished with carriage bolts, washers & acorn cap nuts for safety and strength

Part No.	Finish	Unit Dim.	Display Pkg. Size
DON LP-207-BP	Brass Plated	2 3/4 x 7"	4 x 12"
DON LP-207-DU	Duro Coated	2 3/4 x 7"	4 x 12"
DON LP-207-SL	Silver Coated	2 3/4 x 7"	4 x 12"

Pin Latch Protectors, for Outswinging Doors

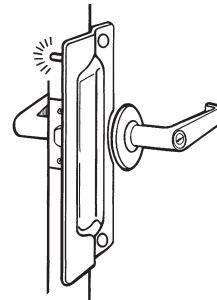

- 12 gauge (.104) steel
- Solid steel pin prevents spreading of door from frame
- Pin is welded on back leaving no visible point of attack from outside
- Fits 2 3/4" and 2 3/8" backsets
- Shelf Pack: 10

Part No.	Finish	Unit Dim.
DON PLP-111-630	Satin S. Steel	3 x 11"
DON PLP-211-DU	Duro Coated	3 x 11"
DON PLP-211-SL	Silver Coated	3 x 11"
DON PMLP-211-BP*	Brass Plated	3 x 11"
DON PMLP-211-DU*	Duro Coated	3 x 11"
DON PMLP-211-SL*	Silver Coated	3 x 11"

*For use with Mortise Locks

Commercial Type, for Outswinging Doors

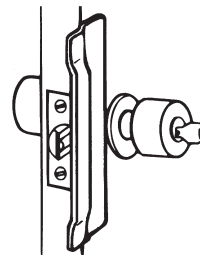

- Polybagged
- Architectural design
- Concealed welded studs with fasteners
- 12 gauge (.104) stainless steel
- 6" for key-in-knob
- 10" for mortise locks
- Shelf Pack: 10

Part No.	Finish	Unit Dim.
DON CLP-110-630	Stainless Steel	2 1/8 x 10"
DON CLP-106-630	Stainless Steel	2 1/8 x 6"

LATCH PROTECTORS

Use with Locks or Escutcheon, 3 1/2" Wide or Less

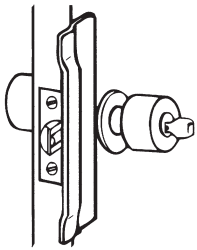

- 6" for key-in-knob
- 10" for Mortise Locks
- Narrow type for outswinging doors
- 12 gauge (.104) steel
- Polybagged
- Shelf Pack: 10

Part No.	Finish	Unit Dim.
DON NLP-206-DU*	Duro Coated	1 1/2 x 6"
DON NLP-206-PC	Prime Coated	1 1/2 x 6"
DON NLP-206-SL	Silver Coated	1 1/2 x 6"
DON NLP-210-DU	Duro Coated	1 1/2 x 10"
DON NLP-210-PC	Prime Coated	1 1/2 x 10"
DON NLP-210-SL	Silver Coated	1 1/2 x 10"

*F/O

Short Type, for Outswinging Doors:

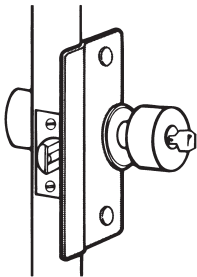

- Furnished with carriage bolts, washers and acorn cap nuts
- May be used on hollow metal door/frame using ANSI strike
- 12 gauge (.104) steel
- Shelf Pack: 10

Part No.	Finish	Unit Dim.	Display Pkg. Size
DON SLP-206-BP	Brass Plated	2 1/2 x 6"	4 x 12"
DON SLP-206-DU*	Duro Coated	2 1/2 x 6"	4 x 12"
DON SLP-206-SL	Silver Coated	2 1/2 x 6"	4 x 12"

*F/O

Angle Type, for Outswinging Doors

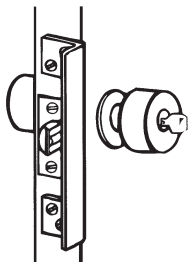

- 10 gauge (.134) steel
- 6" for key-in-knobs
- 10" for Mortise Locks
- 1 1/2" sheet metal screws for wood or metal
- Polybagged
- Shelf Pack: 10

Part No.	Finish	Unit Dim.
DON ALP-206-BC	Brass Coated	6"
DON ALP-206-DU	Duro Coated	6"
DON ALP-206-SL	Silver Coated	6"
DON ALP-210-BC	Brass Coated	10"
DON ALP-210-DU	Duro Coated	10"
DON ALP-210-SL	Silver Coated	10"

Slimline, for Outswinging Doors

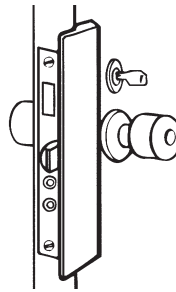

- Sleek appearance
- 5/16" thick (.3125) steel
- Fasteners included
- Polybagged
- Shelf Pack: 10

Part No.	Finish	Unit Dimensions
DON LP-2878-DU	Duro Coated	1 1/2 x 8 1/8 x 5/16"
DON LP-2878-PC*	Prime Coated	1 1/2 x 8 1/8 x 5/16"
DON LP-2878-SL	Silver Coated	1 1/2 x 8 1/8 x 5/16"

*F/O

For Outswinging Doors, Completely Covers the Strike Plate

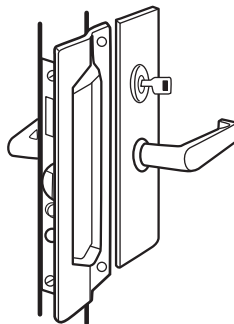

- 12 gauge (.104) steel
- Furnished with carriage bolts, washers and acorn cap nuts for safety and strength
- Dimensions: 3 x 11"
- Shelf Pack: 10

Part No.	Finish
DON MLP-211-BP*	Brass Plated
DON MLP-211-DU	Duro Coated
DON MLP-211-SL	Silver Coated

*F/O

For Outswinging Aluminum Entrance Doors

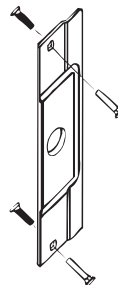

- 12 gauge (.104) steel
- Sex nuts and bolts for secure mounting and professional appearance
- Polybagged
- Shelf Pack: 10

Part No.	Finish	Unit Dim.
DON AL-211-DU	Duro Coated	3 1/2 x 12"
DON AL-211-SL	Silver Coated	3 1/2 x 12"

Fits Adams Rite Latch Lock for Outswinging Doors

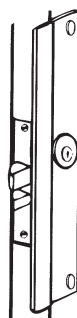

- 12 gauge (.104) steel
- Reversible
- 1/4" offset, 17/16" hole, 1 1/8" backset
- Shelf Pack: 10, Polybagged

Part No.	Finish	Unit Dim.
DON LP-312-DU	Duro Coated	2 5/8 x 12 x 1/8"
DON LP-312-SL	Silver Coated	2 5/8 x 12 x 1/8"
DON LP-312P-DU†	Duro Coated	2 5/8 x 12 x 1/8"
DON LP-312P-SL†	Silver Coated	2 5/8 x 12 x 1/8"

† No center hole

LATCH PROTECTORS

Fits Folger Adams Electric Strike for Outswinging Doors

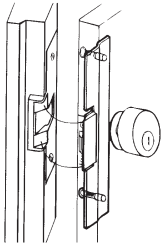

- 12 gauge (.104) steel
- Polybagged
- Shelf Pack: 10

Part No.	Finish	Unit Dim.
DON FLP-111-630	Satin Stainless Steel	1 ³ / ₄ × 11 ¹ / ₄ "
DON FLP-211-BP*	Brass Plated	1 ³ / ₄ × 11 ¹ / ₄ "
DON FLP-211-DU	Duro Coated	1 ³ / ₄ × 11 ¹ / ₄ "
DON FLP-211-SL*	Silver Coated	1 ³ / ₄ × 11 ¹ / ₄ "

*F/O

For Use with Electric Strikes

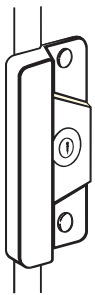

- Available with or without cylinder hole
- Completely encases the keeper for maximum protection
- .104 gauge steel
- Shelf Pack: 10, polybagged

Part No.	Finish	Unit Dim.
DON ELP-208-DU	Duro Coated	3 ¹ / ₂ × 8"
DON ELP-208-SL	silver Coated	3 ¹ / ₂ × 8"

For Use with Electric Strikes

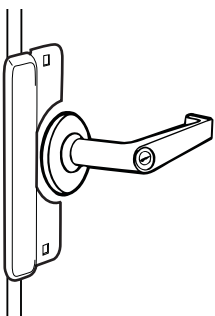

- Available with or without cylinder hole
- Designed to fit most electric strikes
- Fits up to 3³/₄" rose
- Completely encases the keeper for maximum protection

Part No.	Finish	Unit Dim.
DON LELP-208-DU	Duro Coated	3 ¹ / ₂ × 8"
DON LELP-208-SL	Silver Coated	3 ¹ / ₂ × 8"

For Use with Electric Strikes, Exit Devices, Mortise Locks and Keyless Locks

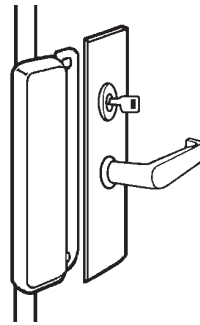

- Deep pocket encases electric strike
- Size: 10 × 2⁵/₈"

Part No.	Finish
DON MELP-210-DU	Duro Coated
DON MELP-210-SL	Silver Coated

Electronic Lock Latch Protector

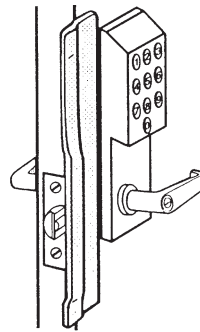

- Works with Simplex, Alarm Lock and Mas Hamilton
- RH and LH Versions Available

Part No.	Finish	Unit Dim.
DON KLP-110 630 RH	Stainless Steel	1 ¹ / ₂ × 10"
DON KLP-110 630 LH	Stainless Steel	1 ¹ / ₂ × 10"

"The Slipper" Latch Guard

Works with Schlage D and AL Series, Corbin-Russwin, Falcon, Sargent, and Arrow Grade 1 Lever Locks

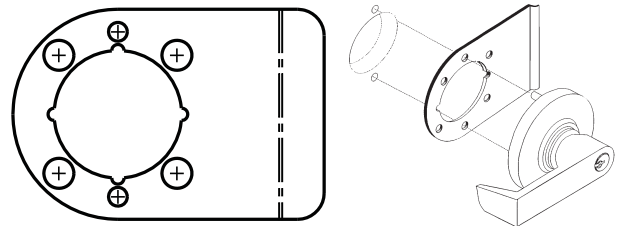

No measuring, drilling or clean up! Just slip *The Slipper* onto the mounting posts. The Slipper type latch guard works with thru bolted cylindrical lever locksets.

- Strong Stainless Steel
- Super-Fast Installation
- Precision Machined for an outstanding appearance

Part No.
DON SLP1-234-630

BOLTS, LATCHES AND CATCHES

Flush Bolt



- Dimensions: 15/16 x 4 1/4"
- 1/8" offset
- Shelf Pack: 10

Part No.	Description
DON 1550-DU-----	1/8" BS, 12" Rod, 313 Dark Bronze
DON 1550-SL-----	1/8" BS, 12" Rod, 628 Aluminum

Flush Bolt for Metal Doors

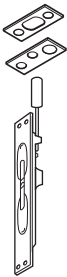

- UL rated for metal doors
- Dimensions: 6 3/4 x 1"
- Shelf Pack: 10

Part No.	Description
DON 1555-605-----	Flush bolt, metal door 6 3/4 x 1"
DON 1555-613-----	Flush bolt, metal door 6 3/4 x 1"
DON 1555-626-----	Flush bolt, metal door 6 3/4 x 1"

Slide Bolt

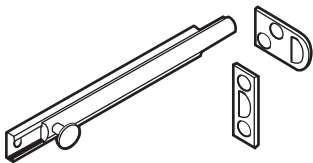

- Furnished with Rim and Mortise strikes
- Solid Brass
- Shelf Pack: 10
- Polybagged

Part No.	Description
DON SB12-605-----	Bolt, Surface 12", US 3

UL Slide Bolt

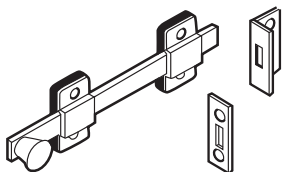

- UL surface bolt
- Furnished with Rim and Mortise strikes
- Solid Brass
- Dimensions: 8"
- Shelf Pack: 10

Part No.	Description
DON 1580-626-----	Surface Bolt, 8"

Surface Bolt

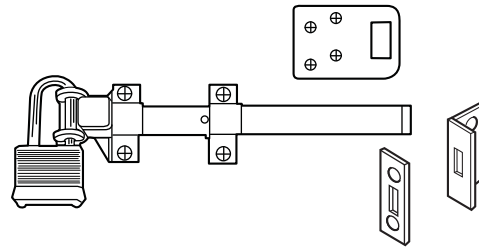

- All stainless steel components
- Top and bottom strikes available
- Padlock not included
- Dimensions: 8", throw: 1"
- Shelf Pack: 10

Part No.	Description
DON 1582-630-----	Slide Bolt, 8"

Ball Latches

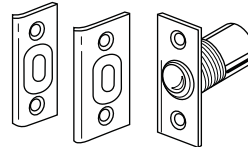

- Packed with narrow and wide strike
- Adjustable
- Dimensions: 2 1/8" x 1"

Part No.	Description
DON 1712-605-----	Ball Latch, Cast brass
DON 1712-613*-----	Ball Latch, Cast brass
DON 1712-626*-----	Ball Latch, Cast brass

*F/O

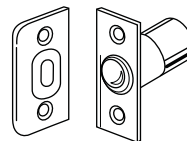

- Packed with full lip round corner strike
- Dimensions: 2 1/4" x 1"

Part No.	Description
DON 1714-605-----	Ball Latch, Cast aluminum
DON 1714-609*-----	Ball Latch, Cast aluminum

*F/O

Hospital Latch

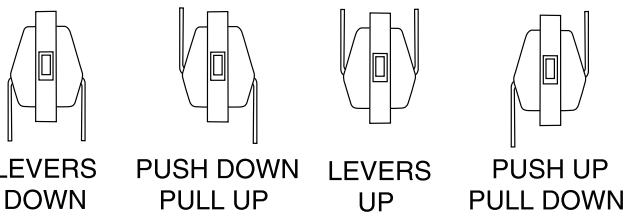
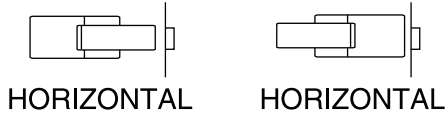
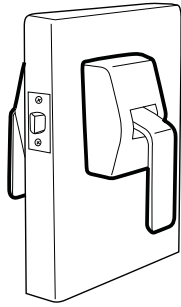

- Non-handed (except for engraved models)

(When ordering engraved models, add the letter **P** after the item number and designate hand)

- Push/Pull latch can be mounted with the handles up, down or horizontal without any modification
- UL listed for all fire doors
- Meets ADA requirements
- Packed with ANSI strike and T strike as standard
- Lever Projection: 3 1/4"
- Bolt 1/2" throw with anti-friction nylon insert
- Shelf pack: 1

Part No.	Back Set	Door
DON 4500 630*	2 3/4"	1 3/4" to 2 1/4"
DON 4550 630*	5"	1 3/4" to 2 1/4"

*F/O

Magnetic Catch

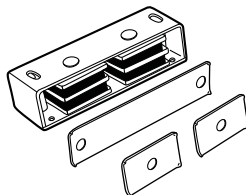

- Dimensions: 3 1/8" x 1" x 3/4"
- Load capacity: 14 lbs.
- Shelf Pack: 10

Part No.	Description
DON 1724-605	Magnetic Catch
DON 1724-609	Magnetic Catch

Elbow Catch

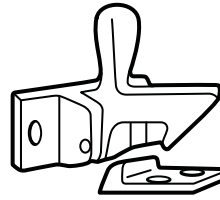

- Cast
- Shelf Pack: 10

Part No.	Description
DON 1590 605	Elbow Catch
DON 1590 626	Elbow Catch

ANSI STRIKES

- 13 gauge (.095)
- Polybagged
- Shelf Pack: 30

Blank Strikes:

Part No.	Finish	Unit Dim.
DON BS-161-605*	Polished Brass	4 7/8 x 1 1/4"
DON BS-161-612	Satin Bronze	4 7/8 x 1 1/4"
DON BS-161-626	Brass Dull Chrome Plated	4 7/8 x 1 1/4"
DON BS-161-630	Stainless Steel	4 7/8 x 1 1/4"

*F/O

For Deadbolt:

Part No.	Finish	Unit Dim.
DON DBS-1478-605*	Polished Brass	4 7/8 x 1 1/4"
DON DBS-1478-626*	Brass Dull Chrome Plated	4 7/8 x 1 1/4"
DON DBS-2478-BP*	Steel Brass Plated	4 7/8 x 1 1/4"
DON DBS-2478-SL*	Steel Silver Coated	4 7/8 x 1 1/4"

*F/O

Mortise Type:

Part No.	Finish	Unit Dim.
DON MST-261-BP	Steel Brass Plated	4 7/8 x 1 1/4"
DON MST-261-SL	Steel Silver Coated	4 7/8 x 1 1/4"

Standard ANSI:

Part No.	Finish	Unit Dim.
DON ST-161-605	Polished Brass	4 7/8 x 1 1/4"
DON ST-161-606*	Satin Brass	4 7/8 x 1 1/4"
DON ST-161-612*	Satin Bronze	4 7/8 x 1 1/4"
DON ST-161-613	Oil Rubbed Bronze	4 7/8 x 1 1/4"
DON ST-161-626	Brass Dull Chrome Plated	4 7/8 x 1 1/4"
DON ST-161-630	Stainless Steel	4 7/8 x 1 1/4"
DON ST-261-BP	Steel Brass Plated	4 7/8 x 1 1/4"
DON ST-261-SL*	Steel Silver Coated	4 7/8 x 1 1/4"

*F/O

REPLACEMENT STRIKES

Replacement Strikes



- 13 gauge (.095)
- Polybagged
- Shelf Pack: 30

Part No.	Finish	Unit Dim.
DON DS-234-605	Polished Brass	2 ³ / ₄ × 1 ¹ / ₈ "

T-Strikes



- 18 gauge (.050)
- Non ferrous base material
- Display package size is 5¹/₄ × 6¹/₂"



• Shelf pack is ten

Part No.	Finish	Unit Dim.
DON TS-234-605	Solid Brass	2 ³ / ₄ × 1 ¹ / ₈ "

Thimble Strike

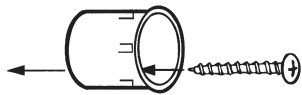

- Polybagged
- Shelf Pack: 20

Part No.	Finish	Unit Dim.
DON TS-100-BP*	Brass Plated	1" Dia.
DON TS-100-CP	Chrome Plated	1" Dia.

*F/O

Hinge Pin

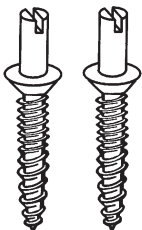

- Commercial — CHP #12 head
- Residential — RHP #10 head
- Polybagged
- Shelf pack is ten pack of two each

Part No.	Description
DON CHP-100-CP	#12 F/4.5" & 5", Chrome Plated
DON RHP-100-CP	#10 F/3.5" & 4", Chrome Plated

EXTENDED STRIKES

2³/₄" Extended Lip Strike

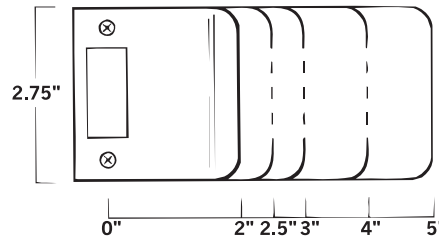

- 13 gauge (.090)
- Polybagged
- Shelf Pack: 10

Part No.	Finish	Unit Dim.
DON EL-202-BP	Steel Brass Plated	2 ³ / ₄ × 2"
DON EL-203-BP	Steel Brass Plated	2 ³ / ₄ × 3"
DON EL-204-BP	Steel Brass Plated	2 ³ / ₄ × 4"
DON EL-205-BP	Steel Brass Plated	2 ³ / ₄ × 5"
DON EL-225-BP	Steel Brass Plated	2 ³ / ₄ × 2 ¹ / ₂ "

2¹/₄" Extended Lip Strike

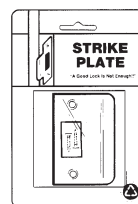
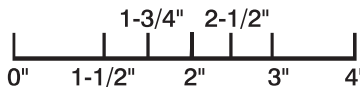
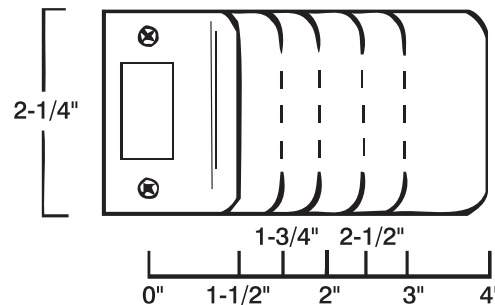

- 18 gauge (.050)
- Display package size is 4 × 6¹/₂"
- Shelf Pack: 10

Part No.	Finish	Unit Dim.
DON EL-102-605†	Polished Brass	2 ¹ / ₄ × 2"
DON EL-102-609†*	Antique Brass	2 ¹ / ₄ × 2"
DON EL-103-605	Polished Brass	2 ¹ / ₄ × 3"
DON EL-103-609	Antique Brass	2 ¹ / ₄ × 3"
DON EL-104-605*	Polished Brass	2 ¹ / ₄ × 4"
DON EL-104-609*	Antique Brass	2 ¹ / ₄ × 4"
DON EL-115-630	Stainless Steel	2 ¹ / ₄ × 1 ¹ / ₂ "
DON EL-125-605	Polished Brass	2 ¹ / ₄ × 2 ¹ / ₂ "
DON EL-125-609	Antique Brass	2 ¹ / ₄ × 2 ¹ / ₂ "
DON EL-175-605	Polished Brass	2 ¹ / ₄ × 1 ³ / ₄ "
DON EL-175-630	Stainless Steel	2 ¹ / ₄ × 1 ³ / ₄ "

*F/O

† Also available with radius corners (F/O)

47/8" Extended Lip ANSI Strike

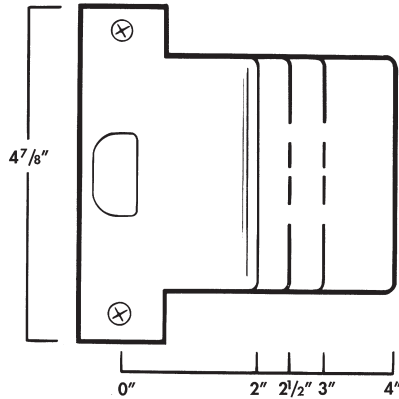

- 13 gauge (.095)
- Polybagged
- Shelf Pack: 5

Part No.	Finish	Unit Dim.
DON EST-102-605	Polished Brass	47/8 x 2"
DON EST-102-612*	Satin Bronze	47/8 x 2"
DON EST-102-630	Stainless Steel	47/8 x 2"
DON EST-103-605*	Polished Brass	47/8 x 3"
DON EST-103-612*	Satin Bronze	47/8 x 3"
DON EST-103-630	Stainless Steel	47/8 x 3"
DON EST-104-605*	Polished Brass	47/8 x 4"
DON EST-104-612*	Satin Bronze	47/8 x 4"
DON EST-104-630*	Stainless Steel	47/8 x 4"
DON EST-125-605*	Polished Brass	47/8 x 2 1/2"
DON EST-125-612*	Satin Bronze	47/8 x 2 1/2"
DON EST-125-630	Stainless Steel	47/8 x 2 1/2"

*F/O

23/4" Extended Lip T-Strike

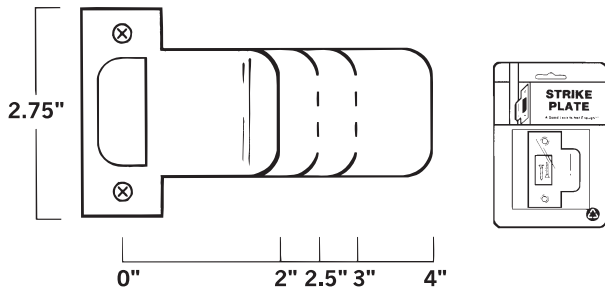

- 18 gauge (.050)
- Display package size is 4 x 6 1/2"
- Shelf Pack: 10

Part No.	Finish	Unit Dim.
DON ETS-102-605	Polished Brass	23/4 x 2"
DON ETS-102-609*	Antique Brass	23/4 x 2"
DON ETS-103-605	Polished Brass	23/4 x 3"
DON ETS-103-630	Satin Stainless Steel	23/4 x 3"
DON ETS-103-609	Antique Brass	23/4 x 3"
DON ETS-104-605	Polished Brass	23/4 x 4"
DON ETS-104-630	Satin Stainless Steel	23/4 x 4"
DON ETS-104-609*	Antique Brass	23/4 x 4"
DON ETS-125-605	Polished Brass	23/4 x 2 1/2"
DON ETS-125-609*	Antique Brass	23/4 x 2 1/2"
DON ETS-125-630	Satin Stainless Steel	23/4 x 2 1/2"

*F/O

SECURITY STRIKES

The use of security strikes is recommended in all lock installations. 3" screws are used in offset holes to maximize the strength of installations. The 3" screws are used to penetrate the 2 x 4" stud located behind most standard door frames. This makes for the strongest application against kick-in attacks. Don-Jo manufactures strikes in 47/8", 8", 12" and 18" lengths for various situations.

All Security Strikes Feature...

- 13 gauge (.095) steel
- Supplied with four 3" screws for extra security
- Shelf Pack: 10

For Deadbolt

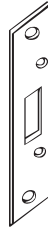

- Display package size is 5 1/4 x 6 1/2"

Part No.	Finish	Unit Dim.
DON 2-SDS-BP	Steel Brass Plated	47/8 x 1 1/4"
DON 2-SDS-SL	Steel Silver Coated	47/8 x 1 1/4"

For Key-In-Knob



- Display package size is 5 1/4 x 6 1/2"

Part No.	Finish	Unit Dim.
DON 2-SS-BP	Steel Brass Plated	47/8 x 1 1/4"
DON 2-SS-SL	Steel Silver Coated	47/8 x 1 1/4"

Adjustable for Deadbolt



- Polybagged

Part No.	Finish	Unit Dim.
DON A-2-SDS-BP	Steel Brass Plated	33/8 x 1 1/4"
DON A-2-SDS-SL	Steel Silver Coated	33/8 x 1 1/4"

Adjustable for Key-In-Knob



Part No.	Finish	Unit Dim.
DON A-2-SS-BP	Steel Brass Plated	33/8 x 1 3/4"
DON A-2-SS-SL*	Steel Silver Coated	33/8 x 1 3/4"

*F/O

Super Strike for Deadbolt



- Display package size is 4 x 16"

Part No.	Finish	Unit Dim.
DON 2-SDS-8-BP	Steel Brass Plated	8 x 1 3/8"
DON 2-SDS-8-SL	Steel Silver Coated	8 x 1 3/8"

Single Hole for Key-In-Knob or Deadbolt

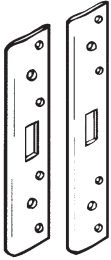

- FL-208W is polybagged
- FL-212W display package size is 4 x 16"

Part No.	Finish	Unit Dim.
DON FL-208W-BP	Brass Plated	8 x 13/4"
DON FL-208W-SL	Silver Coated	8 x 13/4"
DON FL-212W-BP	Brass Plated	12 x 13/4"

Double Hole for 35/8" and 4" Centered Locksets:



- Display package size is 4 x 16"

Part No.	Finish	Unit Dim.
DON FL-212W4-BP	Brass Plated	12 x 13/4"
DON FL-212W4-SL*	Silver	12 x 13/4"

*F/O

Double Hole for 6" Center Holes:



- Display package size is 4 x 16"

Part No.	Finish	Unit Dim.
DON FL-212W6-BP	Brass Plated	12 x 13/4"
DON FL-212W6-SL*	Silver	12 x 13/4"

*F/O

Single Hole for Key-In-Knob or Deadbolt



- Polybagged

Part No.	Finish	Unit Dim.
DON AST-21341-BP*	Brass Plated	18 x 13/4"
DON AST-21341-SL	Silver Coated	18 x 13/4"
DON AST-21381-BP	Brass Plated	18 x 13/8"

*F/O

Double Hole for 35/8" and 4" Centered Locksets:



- Shelf pack is ten
- Polybagged

Part No.	Finish	Unit Dim.
DON AST-21342-BP	Brass Plated	18 x 13/4"
DON AST-21342-SL	Silver Coated	18 x 13/4"
DON AST-21382-BP	Brass Plated	18 x 13/8"
DON AST-21382-SL	Silver Coated	18 x 13/8"

Adapter Rings Allow for use of Grade 1 key-In-Levers on 13/8" Doors

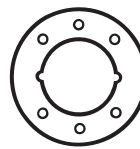

- (.125) Aluminum

Part No.	Finish	Unit Dim.
DON AR-335-605	Brass	3 1/2" O.D.
DON AR-335-613	Oil Rubd Brnz	3 1/2" O.D.
DON AR-335-630	Stainless Stl.	3 1/2" O.D.

Fit Selected Folger Adams, Von Duprin, and Rofu Numbers

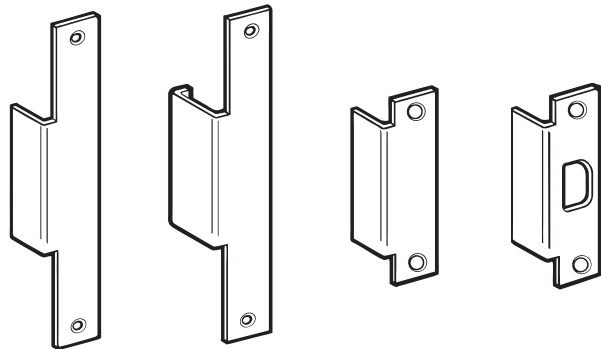

AF-29 AF-29L AF-260 AF-261

- 13 gauge (.095) steel
- Electric Strike Filler
- Aluminum

Part No.	Finish	Unit Dim.
DON AF-29-DU	Duro Coated	9 x 13/8"
DON AF-29-SL	Silver Coated	9 x 13/8"
DON AF-29L-DU	Duro Coated	9 x 13/8"
DON AF-29L-SL	Silver Coated	9 x 13/8"
DON AF-260-DU	Duro Coated	47/8 x 1 1/4"
DON AF-260-SL	Silver Coated	47/8 x 1 1/4"
DON AF-261-DU	Duro Coated	47/8 x 1 1/4"
DON AF-261-SL	Silver Coated	47/8 x 1 1/4"

T-Strike with 160 Cut Out

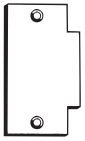

Part No.	Finish	Unit Dim.
DON BTS-160-PC	Prime Coat	2 ³ / ₄ × 1 ¹ / ₂ "

ANSI Cut Out



Part No.	Finish	Unit Dim.
DON FF-45	Prime Coat	4 ¹ / ₂ × 1 ⁵ / ₈ "
DON FF-50	Prime Coat	5 × 1 ⁵ / ₈ "



Part No.	Finish	Unit Dim.
DON FS-260-PC	Prime Coat	4 ⁷ / ₈ × 1 ¹ / ₄ "

Hinge Shim



Part No.	Gauge / Finish	Shims
DON HS-060	16 (.060) / Prime Coat	4 ¹ / ₂ "
DON HS-090	13 (.090) / Prime Coat	4 ¹ / ₂ "

DOOR FILLER PLATES

- Shelf pack: 10
- Polybagged

Converts Sargent's Integra Locks



Part No.	Finish	Unit Dim.
DON CV-2414-SL	Silver Coated	4 ¹ / ₄ × 1 ¹ / ₄ "

86 Cut Out to 161



Part No.	Finish	Unit Dim.
DON CV-86	Prime Coat Steel	8 × 1 ¹ / ₄ "

86 Cut Out to (2)161



Part No.	Finish	Unit Dim.
DON CV-8624	Prime Coat Steel	8 × 1 ¹ / ₄ "

86 Cut Out



Part No.	Finish	Unit Dim.
DON EF-86	Prime Coat Steel	8 × 1 ¹ / ₄ × ³ / ₁₆ "

160/161 Cut Out



Part No.	Finish	Unit Dim.
DON EF-160	Prime Coat Steel	2 ¹ / ₄ × 1"
DON EF-161	Prime Coat Steel	2 ¹ / ₄ × 1 ¹ / ₈ "
DON EF-161-S	Prime Coat Steel	2 ³ / ₄ × 1 ¹ / ₈ "

DOOR FILLER PLATES

Door Hinge Cut Out



Part No.	Finish	Unit Dim.
DON HF-45	Prime Coat Steel	4 1/2 x 1 3/4"
DON SHF-45	Prime Coat Steel	4 1/2 x 1 1/2"

Flush Bolt Cut Out



Part No.	Finish	Unit Dim.
DON EF-634	Prime Coat Steel	6 3/4 x 1"

HINGE REINFORCEMENT

Tabs

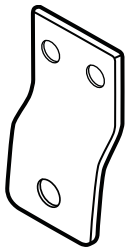

- Dimensions: 1 x 1 1/2"
- Finish: Zinc Plated
- Shelf Pack : 50, bulk

Part No.	Description
DON TB215	Mounting Bracket, F/Latch metal dr

HOLE FILLER PLATES

- Shelf Pack: 10
- Polybagged

Covers Up to 2 1/8" Hole

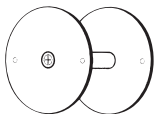

Part No.	Finish	Unit Dim.
DON BF-161-BP	Brass Plated	2 3/8" dia.
DON BF-161-PC	Prime Coat	2 3/8" dia.
DON BF-161-SL	Silver Coated	2 3/8" dia.

Covers Up to 1 1/2" Hole



Part No.	Finish	Unit Dim.
DON BF-178-BP	Brass Plated	1 7/8" dia.
DON BF-178-PC	Prime Coat	1 7/8" dia.
DON BF-178-SL	Silver Coated	1 7/8" dia.

Covers Up to 2 1/8" Hole Under Rim Panic Device

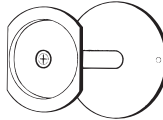

Part No.	Finish	Unit Dim.
DON PDF-161-PC	Prime Coat	2 1/8" hole

SCAR PLATES & REMODELER PLATES

DON-JO MFG., INC. offers a complete line of Scar Plates and Remodeler Plates for repairing or remodeling doors.

Converts 2 3/8" to 2 3/4" Backset

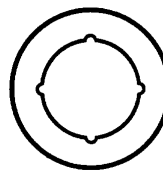

- Fits under rose of key-in-knob or deadbolt locks
- 2 1/8" hole
- Display package size is 5 1/4 x 6 1/2"
- Shelf Pack: 10

Part No.	Finish	Unit Dim.
DON SP-135-605	Polished Brass	3 1/2" O.D.
DON SP-135-609	Antique Brass	3 1/2" O.D.
DON SP-135-612	Satin Bronze	3 1/2" O.D.
DON SP-135-630	Stainless Steel	3 1/2" O.D.

2 5/8" Cylinder Plate

- Indents at 3 & 9 o'clock prevents collar from shifting on wood or metal.
- Can be used with rim or mortise cylinders



Part No.	Finish	Unit Dim.
DON CP-258-BP	Brass Plated	2 5/8" dia.
DON CP-258-SL	Silver Coated	2 5/8" dia.

To Convert 2 3/8" to 2 3/4" Backset

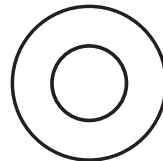

- Fits under deadbolt collars
- Shelf Pack: 10
- Dimensions: 3 1/2" O.D.

Part No.	Finish
DON DSP135-605	Polished Brass
DON DSP135-630	Stainless Steel

SCAR PLATES & REMODELER PLATES

For Door Damaged by Prying

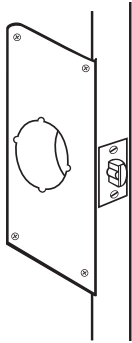

- Dimensions: 9 x 4 1/2 x 2 3/8"
- Fits one side of door with curved lip
- Fits under key-in-knob
- Shelf Pack: 10, polybagged

Part No.	Finish
DON EM-4-630	-----Satin Stainless Steel

For Modernizing or Decorating

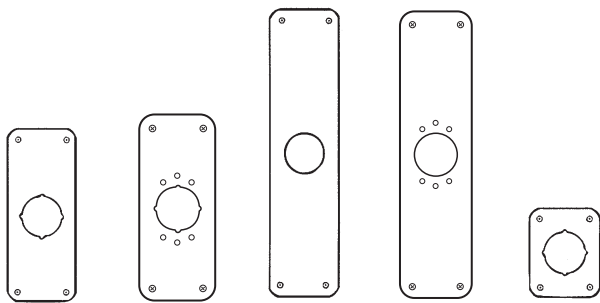

RP-13509 RP-13509-2 RP-13515 RP-13515-2 RP-13545

- .032 thick
- Polybagged
- Shelf Pack: 10
- Display package size is 7 1/2 x 13"

Part No.	Finish	Unit Dim.
DON RP-13509-605	-----Polished Brass	-----3 1/2 x 9"
DON RP-13509-609	-----Antique Brass	-----3 1/2 x 9"
DON RP-13509-612*	-----Satin Bronze	-----3 1/2 x 9"
DON RP-13509-630	-----Stainless Steel	-----3 1/2 x 9"
DON RP-13509-2-605	-----Polished Brass	-----3 1/2 x 9"
DON RP-13509-2-609	-----Antique Brass	-----3 1/2 x 9"
DON RP-13509-2-612*	-----Satin Bronze	-----3 1/2 x 9"
DON RP-13509-2-630	-----Stainless Steel	-----3 1/2 x 9"
DON RP-13515-605*	-----Polished Brass	-----3 1/2 x 15"
DON RP-13515-613	-----Oil Rubbed Bronze	-----3 1/2 x 15"
DON RP-13515-630	-----Stainless Steel	-----3 1/2 x 15"
DON RP-13515-2-605*	-----Polished Brass	-----3 1/2 x 15"
DON RP-13515-2-630*	-----Stainless Steel	-----3 1/2 x 15"
DON RP-13545-605	-----Polished Brass	-----3 1/2 x 4 1/2"
DON RP-13545-609*	-----Antique Brass	-----3 1/2 x 4 1/2"
DON RP-13545-612	-----Satin Bronze	-----3 1/2 x 4 1/2"
DON RP-13545-630	-----Stainless Steel	-----3 1/2 x 4 1/2"
DON RP-13545-2-605	-----Polished Brass	-----3 1/2 x 4 1/2"
DON RP-13545-2-609*	-----Antique Brass	-----3 1/2 x 4 1/2"
DON RP-13545-2-612*	-----Satin Bronze	-----3 1/2 x 4 1/2"
DON RP-13545-2-630	-----Stainless Steel	-----3 1/2 x 4 1/2"

*F/O

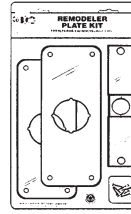

Kit Contents:

- 2 ea. RP-13509
- 1 ea. CV-86-C and all fasteners

Part No.	Finish
DON RPK-109-605	-----Polished Brass
DON RPK-109-630	-----Stainless Steel

FILLER PLATES

Filler Plate Kits

- Shelf Pack: 10



DON FPK-86
For 86 cut out



DON FPK-161
For 161 cut out

Part No.	Finish	Contents
DON FPK-86	-----Prime Coat	-----EF-86; BS-260-PC
DON FPK-161	-----Prime Coat	-----BF-161; EF-161; FS-260-PC

PUSH, PULL AND KICK PLATES

Kick Plates

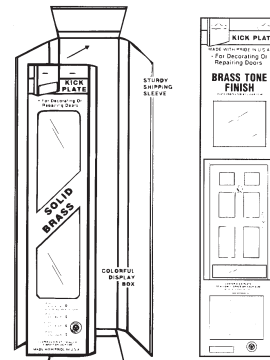

For decorating or repairing doors. Innovative packaging includes an outer corrugation that insures the inner package will remain fresh for display. Package allows for hanging or stacking.

- Display package size is 8 1/4 x 38 1/2"
- Shelf Pack 1

Part No.	Finish	Unit Dim.
DON KP-834-605	-----Solid Brass	-----8 x 34"
DON KP-834-630	-----Stainless Steel	-----8 x 34"

PUSH, PULL AND KICK PLATES

Push and Pull Plates

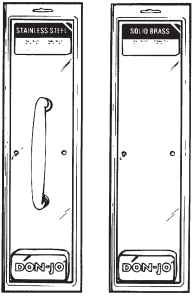

- 18 gauge (.050) material
- Display package size is 4¹/₄ × 17¹/₄"
- Shelf Pack: 10

Part No.	Finish	Unit Dim.
DON PS-13515-605	Solid Brass	3 ¹ / ₂ × 15"
DON PS-13515-613	Oil Rubbed Bronze	3 ¹ / ₂ × 15"
DON PS-13515-630	Stainless Steel	3 ¹ / ₂ × 15"
DON PL-13515-605	Solid Brass	3 ¹ / ₂ × 15"
DON PL-13515-613	Oil Rubbed Bronze	3 ¹ / ₂ × 15"
DON PL-13515-630	Stainless Steel	3 ¹ / ₂ × 15"

Push Plate

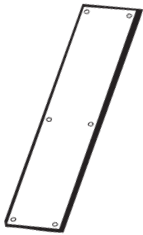

- Beveled edges, adhesive mounting, rounded corners, cylinder cut-outs are available.
- Other finishes include clear plastic and Kydex stock colors (F/O).
- Shelf Pack: 10

Part No.	Finish	Unit Dim.
DON 71-613	Oil Rubbed Bronze	4 × 16"
DON 71-628	Aluminum Anodized	4 × 16"
DON 71-605	Polished Brass	4 × 16"
DON 71-630	Satin Stainless Steel	4 × 16"
DON CFK71-630	Satin Stainless Steel	4 × 16", w/2 ¹ / ₈ " hole

Pull Plate

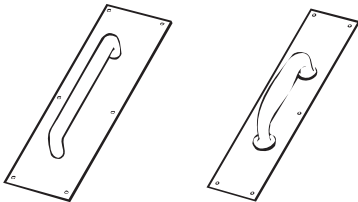

- 7110, 7111, CTC: 5¹/₂"
- CFK7115, CTC: 6"
- Shelf Pack: 1

Part No	Finish	Unit Dim.
DON 7110-613	Oil Rubbed Bronze	4 × 16"
DON 7110-628	Aluminum Anodized	4 × 16"
DON 7110-605	Polished Brass	4 × 16"
DON 7110-630	Satin Stainless Steel	4 × 16"
DON 7111-630	Satin Stainless Steel	4 × 16"
DON CFK7115-630	Satin Stainless Steel	4 × 16", w/2 ¹ / ₈ " hole

For 2¹/₂" clearance add prefix "H" (F/O)

Commercial Kick Plates

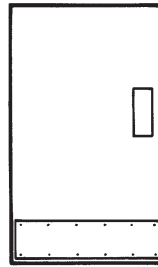

Used on doors subject to marring or damage from foot traffic.

- 18 gauge (.050 Metal)
- Individually packaged with screws
- Fully threaded to the head stainless steel sheet metal screws plated to finish
- Furnished with grain or satin finish running horizontally to door

Part No.	Finish	Unit Dim.
DON 90-10 × 34-605	Polished Brass	10 × 34"
DON 90-10 × 34-613	Oxidized Bronze	10 × 34"
DON 90-10 × 34-628	Anodized Alum	10 × 34"
DON 90-10 × 34-630	Stainless Steel	10 × 34"
DON 90-12 × 34-630	Stainless Steel	12 × 34"
DON 90-8 × 34-605	Polished Brass	8 × 34"
DON 90-8 × 34-613	Oxidized Bronze	8 × 34"
DON 90-8 × 34-630	Stainless Steel	8 × 34"

Vertical Rod Protector

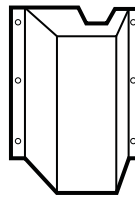

#81
For use on
right hand
reverse doors

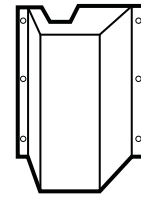

#83
For use on
left hand
reverse doors

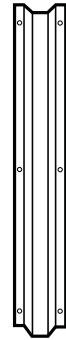

#85
Rod Cover

- Assist in handicap conformance
- Use in hospitals, schools, etc.
- Fire rated
- Stainless Steel, Satin finish

Part No.	Description	Unit Dim.
DON 81-630	Guard, Vert. Rod Protector RH	2 ¹ / ₈ " projection
DON 83-630	Guard, Vert. Rod Protector LH	2 ¹ / ₈ " projection
DON 85-630	Vertical Rod Cover	10 × 1 ¹ / ₁₆ "

KNOBS AND DOOR PULLS

Solid Brass Replacement Knobs

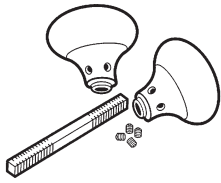

- Includes spindle, four set screws and two knobs
- Shelf Pack: 10
- Display packaged

Part No. **Finish** **Unit Dim.**
 DON BK-225-605 ---Solid Brass-----2 1/4"

Door Pull

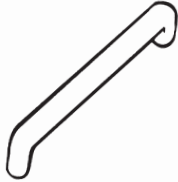

- 10" center to center, 1" diameter
- Shelf Pack: 1

Part No. **Finish** **Unit Dim.**
 DON 20-613 --Oxidized Bronze ----11 x 3 x 2"
 DON 20-630 --Stainless Steel -----11 x 3 x 2"

Cast Door Pulls



35



36

- Dimensions: 7 1/2" x 2" x 1 1/2"
- CTC: 5 1/2"
- Shelf Pack: 1

Part No.	Description
DON 35-605-----	Cast Door Pull
DON 35-613-----	Cast Door Pull
DON 35-626-----	Cast Door Pull
DON 36-605-----	Cast Door Pull
DON 36-613-----	Cast Door Pull
DON 36-626-----	Cast Door Pull

Offset Door Pulls

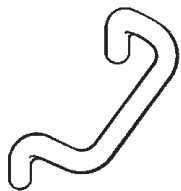

- Made from solid bar stock
- Finishes: 613 and 630

Part No.	Description
DON 1156-613 ----	Pull, Offset 8", CTC 1" dia
DON 1156-630 ----	Pull, Offset 8", CTC 1" dia
DON 1157-613 ----	Pull, Offset 10", CTC 1" dia
DON 1157-630 ----	Pull, Offset 10", CTC 1" dia
DON 1158-613 ----	Pull, Offset 12", CTC 1" dia
DON 1158-630 ----	Pull, Offset 12", CTC 1" dia

Cylinder Pull



- Hole: 1 1/4"
- Dimensions: 2 x 3 3/4"
- Shelf Pack: 10

Part No. **Description**
 DON 1874-630-----Cylinder Pull

DOOR STOPS, HOLDERS AND BUMPERS

Door Stops

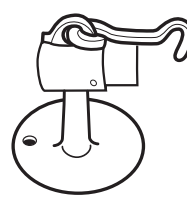

1473

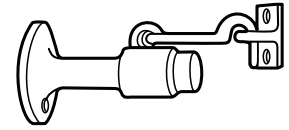

1477

- Cast Brass
- WS, MS, Exp. Shield and Plastic Anchor
- Shelf Pack: 10

Part No.	Description
DON 1473-626-----	2 1/4" base, 3" projection
DON 1477-626-----	2 1/4" base, 3 1/2" projection

Floor Stops

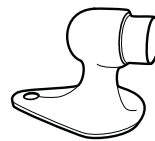

1450

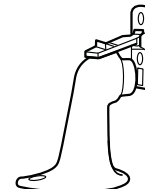

1453

- Cast Brass
- Wood screws and exp. shield
- Shelf Pack: 10

Part No.	Description
DON 1450-613-----	2 1/8" projection, 2 5/8" x 1 5/8" base
DON 1453-626-----	2 3/4" projection, 2 1/4" x 1 1/4" base

Detention Stop



- 4" overall
- Shelf Pack: 10
- Black finish

Part No.	Description
DON 1462 BLK-----	Detention Stop, 1 1/4" x 2 1/2"

DOOR STOPS, HOLDERS AND BUMPERS

Door Holders

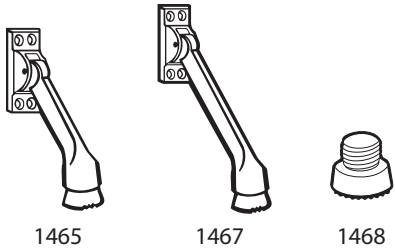

- Solid brass
- Shelf Pack: 10

Part No.	Description
DON 1465-605	4" projection
DON 1465-613*	4" projection
DON 1465-626	4" projection
DON 1467-605	5" projection
DON 1467-626	5" projection
DON 1468	Rubber replacement tip for Door Holder

*F/O



- Cast aluminum
- Shelf Pack: 10

Part No.	Description
DON 1455-626	4" projection
DON 1455 BP*	4" projection
DON 1455 DU*	4" projection

*F/O

Dome Floor Stops

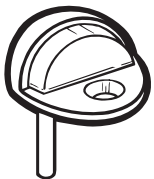

- Cast Brass
- W/S and MS and Exp. Shield, with plastic anchor
- 1/4"H x 15/8" dia base

Part No.	Description
DON 1440-605	Low Dome style
DON 1440-613	Low Dome style
DON 1440-626	Low Dome style

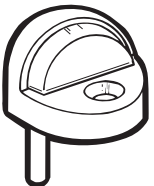

- Cast Brass
- W/S and MS and Exp. Shield, with plastic anchor
- 1/2"H x 15/8" dia base

Part No.	Description
DON 1442-605	High Dome style
DON 1442-613	High Dome style
DON 1442-626	High Dome style

Applied Stop

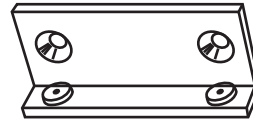

- For use with single or double doors without stops
- 7 gauge (.1875)
- Supplied with machine and wood screws
- Dimensions: 1 1/2" x 3/4" x 3 1/2"
- Shelf Pack: 10

Part No.	Description
DON 1420 613	Applied Stop

Wrought Wall Bumpers

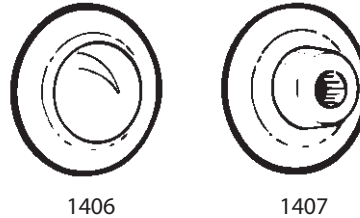

- Plastic anchor and plastic dry wall anchor
- 2 1/2" diameter
- Shelf Pack: 50

Part No.	Description
DON 1406 605	Wrought Wall Bumper
DON 1406 613	Wrought Wall Bumper
DON 1406 630	Wrought Wall Bumper
DON 1407 605	Wrought Wall Bumper, Concave
DON 1407 613	Wrought Wall Bumper, Concave
DON 1407 626	Wrought Wall Bumper, Concave
DON 1407 630	Wrought Wall Bumper, Concave

Door Silencers

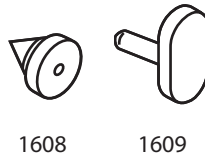

- Gray rubber finish
- Shelf Pack: 100

Part No.	Description
DON 1608	Door Silencer, for metal frame
DON 1609	Door Silencer, for wood frame

ACCESSORY HARDWARE

Door Flip Guards

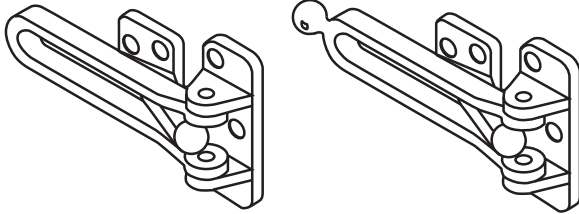

1603

1604

- Ball bearing design
- Black rubber shim available for both models
- Shelf Pack: 10

Part No.	Description
DON 1603-605	Flip Guard, Alum.
DON 1603-626	Flip Guard, Alum.
DON 1604-605	Flip Guard, Brass
DON 1604-626	Flip Guard, Brass

*F/O

Heavy-Duty Crash Chains

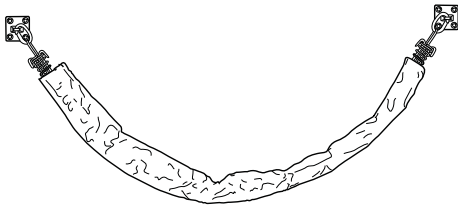

- Gray Vinyl Cover
- Shelf Pack: 10

Part No.	Description
DON HDCC-2012 626	20 1/2"
DON HDCC-2512 626	25 1/2"
DON HDCC-3012 626	30 1/2"

Door Viewers

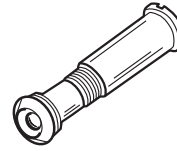

DV90
1/2" Installation Hole

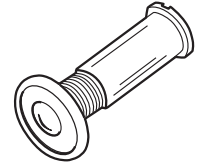

DV180
9/16" Installation Hole

- For Doors 1 3/8" to 2" thickness
- With Plastic lens
- Shelf Pack: 10

Part No.	Finish
DON DV90-605	90° view, Pol. Brass
DON DV90-626	90° view, Dull Brass
DON ULDV90-605	90° view, Pol. Brass
DON ULDV90-626	90° view, Dull Brass
DON DV180-605	180° view, Pol. Brass
DON DV180-626	180° view, Dull Brass
DON ULDV180-605	180° view, Pol. Brass
DON ULDV180-626	180° view, Dull Brass

Pocket Door Locks

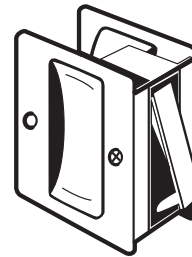

PDL-100
Passage

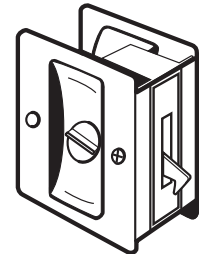

PDL-101
Privacy

- Field reversible
- Adjustable for various door thickness
- Includes pin and screws for 1 3/4" door
- Dimensions: 2 1/2 x 2 3/4"
- Shelf Pack: 10

Part No.	Description
DON PDL-100-605	Passage, Polished Brass
DON PDL-100-609*	Passage, Oxidized Brass
DON PDL-100-613	Passage, Oxidized Bronze
DON PDL-100-625	Passage, Bright Chrome
DON PDL-100-626*	Passage, Dull Chrome
DON PDL-101-605	Privacy, Polished Brass
DON PDL-101-609*	Privacy, Oxidized Brass
DON PDL-101-613	Privacy, Oxidized Bronze
DON PDL-101-625	Privacy, Bright Chrome
DON PDL-101-626*	Privacy, Dull, Chrome

*F/O

SIGNS

Decal



- Decal
- White on Blue
- 4" x 4"

Part No.
DON HD-1

Handicap Accessible



- ADA Sign
- Blue, with raised white lettering
- 6" x 9"
- Braille translation on sign
- ADA compliant

Part No.
DON HS-9070-06

Men/Women/Handicap



- ADA Sign
- Blue, with raised white lettering
- 6" x 9"
- Braille translation on sign
- ADA compliant

Part No.
DON HS-9070-32

Men/Women/Handicap



- Title 24 Sign
- Blue, with raised white lettering
- Braille translation on sign

Part No.: DON CHS-3

Men's/Handicap



- ADA Sign
- Blue, with raised white lettering
- 6" x 9"
- Braille translation on sign
- ADA compliant

Part No.
DON HS-9070-01

Men's /Handicap



- ADA Sign
- Blue, with raised white lettering
- Braille translation on sign

Part No.
DON CHS-1

Women's/Handicap



- ADA Sign
- Blue, with raised white lettering
- 6" x 9"
- Braille translation on sign

Part No.
DON HS-9070-05

Women/Handicap



- Title 24 Sign
- Blue, with raised white lettering
- Braille translation on sign

Part No.
DON CHS-2

Restrooms



- ADA Sign
- Blue, with raised white lettering
- 6" x 9"
- Braille translation on sign
- ADA compliant

Part No.
DON HS-9070-03

Men's Room

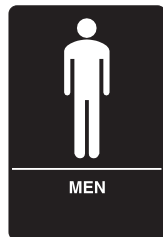

- ADA Sign
- Blue, with raised white lettering
- 6" x 9"
- Braille translation on sign
- ADA compliant

Part No.
DON HS-9070-02

Women's Room



- ADA Sign
- Blue, with raised white lettering
- 6" x 9"
- Braille translation on sign
- ADA compliant

Part No.
DON HS-9070-04

Boy's/Handicap



- ADA Sign
- Blue, with raised white lettering
- Braille translation on sign

Part No.
DON HS-9070-07

Boy's/Handicap



- ADA Sign
- Blue, with raised white lettering
- Braille translation on sign

Part No.
DON CHS-4

Girl's/Handicap



- ADA Sign
- Blue, with raised white lettering
- Braille translation on sign

Part No.
DON HS-9070-08

Girl's/Handicap



- ADA Sign
- Blue, with raised white lettering
- Braille translation on sign

Part No.
DON CHS-5

SIGNS

No Smoking



- ADA Sign
- Blue, with raised white lettering
- 6" x 9"
- Braille translation on sign
- ADA compliant

Part No.
DON HS-9070-22

Men, Women, Restroom

MEN

WOMEN

RESTROOM

- Blue, with raised white lettering
- 13/4" x 6"
- Braille translation on sign

Part No.	Description
DON HS-9070-46	Men Sign
DON HS-9070-47	Women Sign
DON HS-9070-48	Restroom Sign

Exit



- ADA Sign
- Blue, with raised white lettering
- 6" x 6"
- Braille translation on sign
- ADA compliant

Part No.
DON HS-9070-35

Telephone



- ADA Sign
- Blue, with raised white lettering
- 6" x 9"
- Braille translation on sign
- ADA compliant

Part No.
DON HS-9070-27

Stairs



- ADA Sign
- Blue, with raised white lettering
- 6" x 9"
- Braille translation on sign
- ADA compliant

Part No.
DON HS-9070-24

Decals

THIS DOOR TO REMAIN UNLOCKED DURING BUSINESS HOURS

THESE DOORS TO REMAIN UNLOCKED DURING BUSINESS HOURS

Part No.	Description
DON DD-1	Sign, "This Door" Black on Clear
DON DD-2	Sign, "This Door" White on Black
DON DD-3	Sign, "These Doors" Black on Clear
DON DD-4	Sign, "These Doors" White on Black