















SERVICE PARTS KITS

Ace Factory Original Parts now in Convenient Service Kits for Locksmiths! Ace Locking Cam and Tumbler Service Kits from Chicago Lock save invaluable time! They provide all the parts needed to service locks in one compact container. No more wasted trips back to the shop to find forgotten tumblers, springs... it's all right at your fingertips.

Ace® Tumbler Service Kit



Ace® Tumbler Service Kit







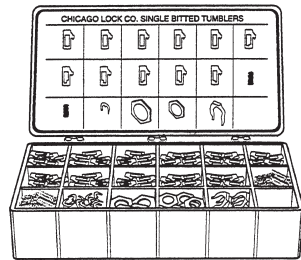









- 
2913-T-1
42495-002
- 
2913-T-2
42506-002
- 
2913-T-3
42517-002
- 
2913-T-4
42528-002
- 
2913-T-5
42539-002
- 
2913-T-6
42550-002
- 
2913-T-7
42561-002
- 
Tumbler Springs
2929-11M
42872-002
- 
Tumbler Springs
2929-11M
42872-002
- 
2913-B-1
42429-002
- 
2913-B-3
42440-002
- 
2913-B-5
42451-002
- 
Assembly Pin
22-42-HY
20279-927
- 
Depth Key

Part No.: CHL D9630

Single Bitted Service Kit



Single Bitted Service Kit







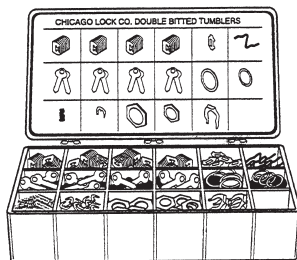





- 
#1 - 41043-002
- 
#M13
41094-002
- 
#M15
41096-002
- 
#M31
41095-002
- 
#2 - 41050-002
- 
#M35
41091-002
- 
#M51
41092-002
- 
#M53
41093-002
- 
#3 - 41065-002
- 
Tumbler Spring
37647-002
- 
Crescent Spring
37193-002
- 
Crescent Ring
37512-506
- 
Hex Nut
40174-002
- 
#4 - 41076-002
- 
Cam Nut
47753-002
- 
Retaining Clip
22058-002
- 
#5 - 41087-002

Part No.: CHL D9094

Double Bitted Service Kit



Double Bitted Service Kit

- 
Tumbler Assemblies
Standard - 43445-019
Off Center
Right - 43446-019
Left - 43443-019
K4W - 43447-019
- 
Double Bitted
Tumblers
41098-002
- 
Tumbler Springs
40461-019
- 
Keyblanks
K4S - 83001-019
K4R - 83002-019
K4L - 83003-019
- 
K4W Keyblanks
83004-019
- 
Flat Washer (3/4 I.D.)
41307-580
- 
Lock Washer (1/2 I.D.)
27447-002
- 
Crescent Spring
37193-002
- 
Crescent Ring
37512-506
- 
Hex Nut
40174-002
- 
Cam Nut
47753-002
- 
Retaining Clip
22058-002

Part No. CHL D9095

Tumbler Assemblies

CHL 3103R K4R-----Uncoded
CHL 3103S K4-----Uncoded

CHL 3104L K4L KD-----Coded
CHL 3104R K4R KD-----Coded

CHL 3104S K4 KD -----Coded
CHL 3104W K4W KD -----Coded

ACE II CAM-TYPE UNIVERSAL FUNCTION LOCKS

Features

- Patented Ace II assembly
- All brass construction
- Center plug contains anti-drill pin for added security
- Rotation cams are now provided in 90° or 180° rotation
- Key removal at 12 and 3 o'clock positions or the 12 and 9 o'clock positions.
- Standard finish is Polished Nickel
- Furnished with straight locking cams which can be mounted vertically or horizontally and also a 1/4" offset cam. Cams are 1/8" thick x 3/4" wide.
- Two keys furnished per lock

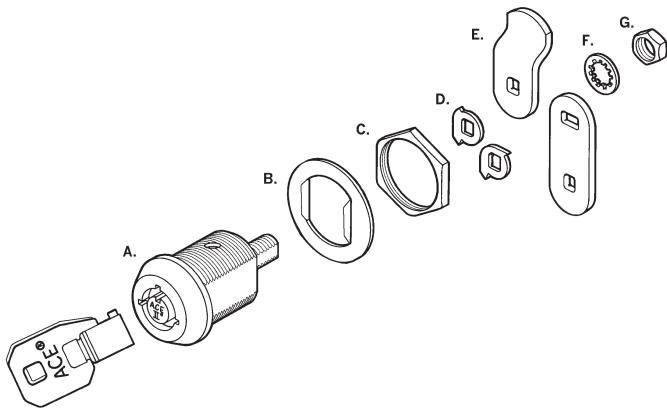

- A. Lock Cylinder
 - B. Anchor Washer
 - C. Large Body Nut
 - D. Stop Cam*
 - E. Locking Cams
 - F. Lock Washer
 - G. Hex Nut
- *see options below

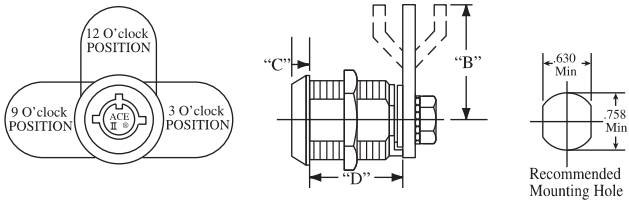

Key Rotation/Removal

Determined by the stop cam you select how it is positioned:

- 180° clockwise rotation — key removal at 12 o'clock.
- 90° clockwise rotation — key removal at 12 and 3 o'clock.
- 180° counter clockwise rotation — key removal at 12 o'clock.
- 90° counter clockwise rotation — key removal at 12 and 9 o'clock.

Part No.	"B"	"C"	"D"
CHL 4198	1 1/8"	23/64"	19/32"
CHL 4153	1 1/8"	1/4"	11/16"
CHL 4152	1 1/8"	13/64"	15/16"
CHL 4160	1 1/8"	13/64"	13/32"
CHL 4160-25	1 1/8"	13/64"	1 1/2"

CAM LOCKS

Double Bitted Cam Lock

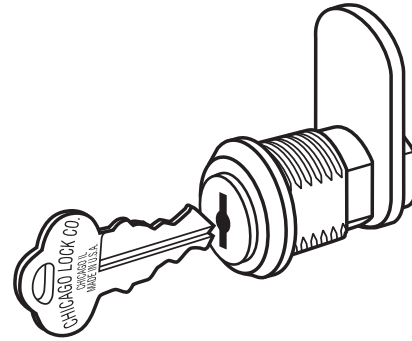

Features

- Eleven criss-cross blade tumbler plug in 3/4" dia.
- Die cast barrel with two flats — 5/8" across
- Key and cam rotation 90° from locked (12 o'clock) to unlocked (3 o'clock) position with keypull in locked position only
- Straight cam furnished is 1/8" thick x 3/4" wide
- Standard finish is Polished Nickel
- Two keys furnished per lock

1800 Series:

No.'s 3186 and 3205:

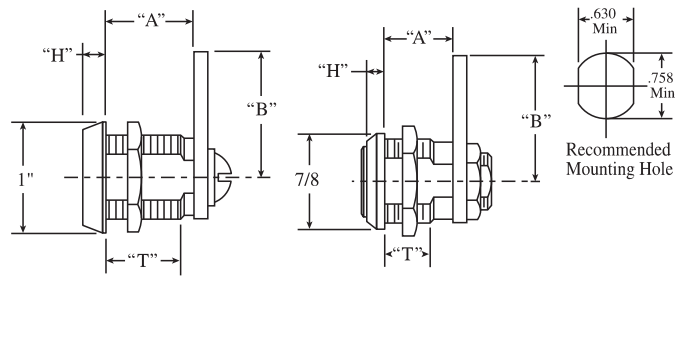

Part No.	"A"	"B"	"H"	"T"
CHL 3205	7/16"	1 1/8"	13/64"	15/64"
CHL 3186	5/8"	1 1/8"	5/32"	13/32"
CHL 1801	13/16"	1 1/8"	13/64"	11/16"
CHL 1802	1 1/16"	1 1/8"	13/64"	15/16"
CHL 1804	1 1/2"	1 1/8"	13/64"	1 13/32"

CAM LOCK CONTINUED

Single Bitted Cam Lock

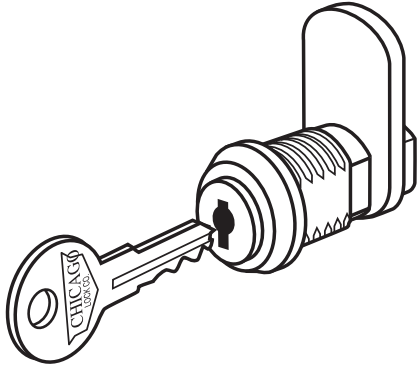

Features

- Five disc tumbler plug in 3/4" diameter
- Die cast barrel with two flats—5/8" across
- Key and cam rotation 90° from locked (12 o'clock) to unlocked (3 o'clock) position with keypull in locked position only
- Straight cam furnished is 1/8" thick x 3/4" wide
- Standard finish is Polished Nickel
- Two keys furnished per lock

1700 Series:

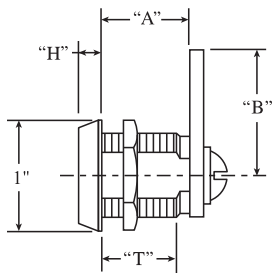

No. 3705 and 3786:

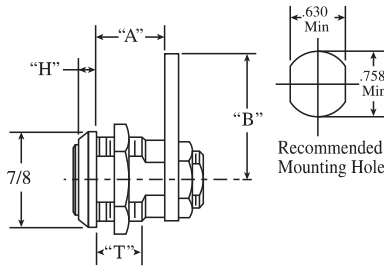

Part No.	"A"	"B"	"H"	"T"
CHL 3705	7/16"	1 1/8"	1/4"	13/64"
CHL 3786	5/8"	1 1/8"	13/64"	13/32"
CHL 1701	13/16"	1 1/8"	13/64"	11/16"
CHL 1702	1 1/16"	1 1/8"	13/64"	15/16"
CHL 1703	13/16"	1 1/8"	13/64"	17/64"
CHL 1704	1 1/2"	1 1/8"	13/64"	1 13/32"

SWITCH LOCKS

WARNING: Improper connection to circuitry may result in shock. Since Chicago Lock does not control the use of its products, external wiring, switch lock selection, and/or use is not the responsibility of Chicago Lock Company.

Single Pole, Single Throw

Patented Ace II Lock Assembly

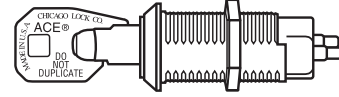

- Maintaining contact switch operated by manually rotating inserted key 90° clockwise from open to closed position.
- Momentary contact switch locks feature spring return from closed to open position after 90° clockwise key rotation to closed position.
- Switches are U.L. Recognized
- Standard finish is Bright Chrome
- Two keys are furnished per lock

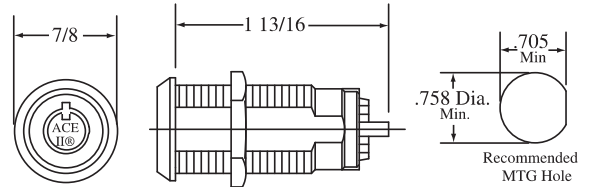

Part No.	Keypull	Contact
CHL 4073-1DC	OFF Only	Maintaining
CHL 4073-2DC	OFF & ON	Maintaining
CHL 4073-70DC	OFF Only	Momentary

Single Pole, Single Throw

Double Bitted Assembly with Eleven Criss-Cross Blade Tumblers

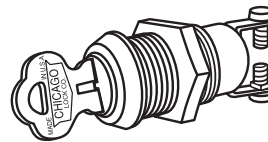

- Lock operation same as 4073 Series
- Switches are UL Recognized
- Standard finish is Bright Chrome
- Two keys furnished per lock

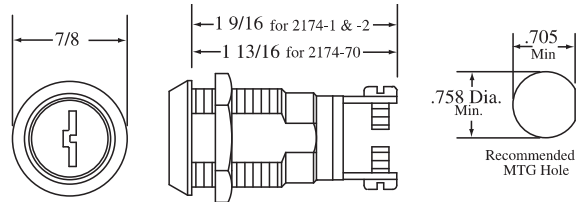

Part No.	Keypull	Contact
CHL 2174-1DC	OFF Only	Maintaining
CHL 2174-2DC	OFF & ON	Maintaining
CHL 2174-70DC	OFF Only	Momentary

SWITCH LOCKS CONTINUED

Single Pole, Double Throw

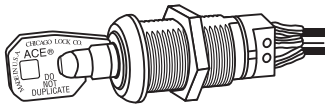

4235 Series: Patented Ace II Lock Assembly

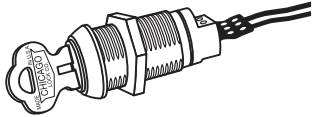

3535 Series: Double Bitted Assembly with Eleven Criss-Cross Blade Tumblers

Features

- 7 amps resistive/4 amps inductive @ 115 VAC or 28 VDC
- Reliable snap action switch provides many thousands of electrical contacts without failure
- Terminals designed to accept "AMP" .058 pin receptacles
- Switches are U.L. & CSA listed
- Standard finish is Bright Chrome
- Furnished with 10 inch, 20 gauge stranded wire
- Two keys furnished per loc

Ace II Switch Locks—SPDT:

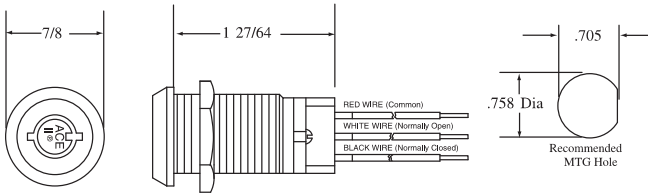

Part No.	Keypull	Rotation
CHL 4235DC	2 positions	180°CW
CHL 4235BDC	1 position	165°CW

DRAWER & DOOR LOCK

Special Purpose

Features

- Six disc tumbler plug in 3/4" dia.
- Die cast barrel with two flats — 21/32" across
- Key and cam rotation 90° from locked (12 o'clock) to unlocked (3 o'clock) position with keypull in both positions
- Designed to be used with customer's latching mechanism
- Standard finish is Satin Nickel
- Two keys furnished per lock

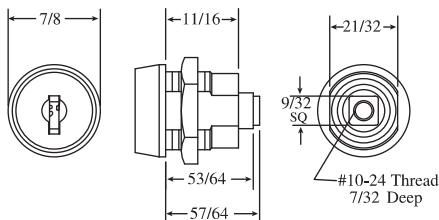
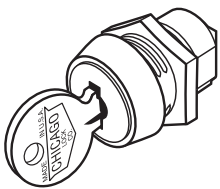

Part No.
CHL 1725-6TNH

SCREW TYPE LOCKS

ACE II

Seven Pin Tumbler

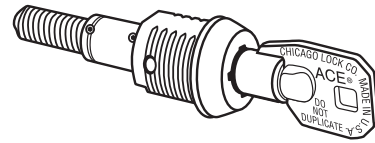

Features

- Patented Ace II lock assembly in 3/4" diameter
- Barrel with two flats, 5/8" across
- 360° key rotation with keypull every 180° (12 and 6 o'clock)
- Two keys furnished per lock
- Includes body nut
- Additional stud lengths available to special order

Minimum order and extended lead time may apply

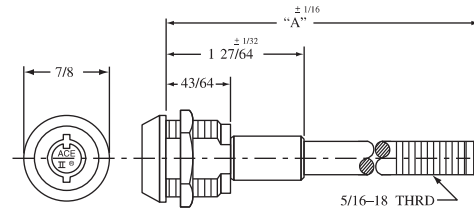

Part No. "A"
CHL SA4107-----71/32"

BOLT TYPE LOCKS

Features

- Five disc tumbler
- Removable plug feature
- Steel locking bolt
- Two keys furnished per lock

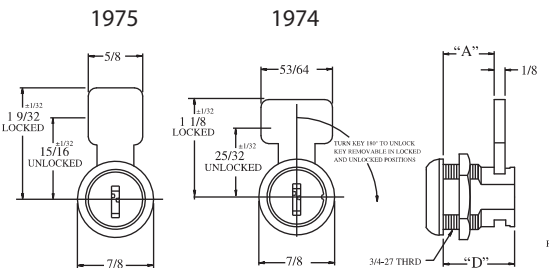
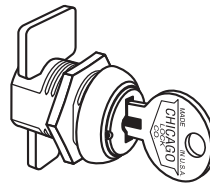

Part No.	"A"	"D"
CHL 1968	57/64"	15/32"
CHL 1974	19/32"	27/32"
CHL 1975	21/32"	57/64"

SLIDING DOOR LOCK

Single Bitted

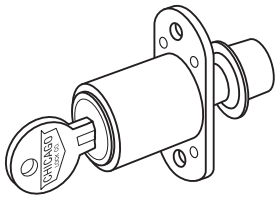

Features

- Five disc tumbler plug in 7/8" diameter
- Die cast barrel
- Utilizes a spring bolt that locks by pushing the cylinder in and released by turning the key 90° from locked (12 o'clock) to unlocked (3 o'clock) position

- Keypull in locked and unlocked positions
- Standard finish—Satin Chrome
- Mounting plate is 5/64" x 7/8" x 2" with 1 1/2" between mounting hole centers
- Two keys furnished per lock

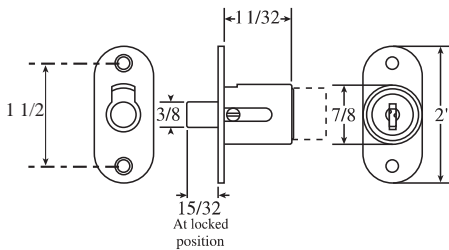

Part No.
CHL 1770

T HANDLE ASSEMBLIES

4200 Series "T" Handle

"T" Handle, 1-Way 90° Clockwise Less Cylinder

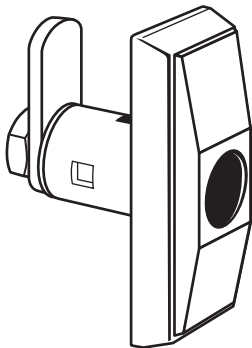

- Accepts standard and long cylinder locks which meet NAMA dimension standards
- Textured finish for scratch resistance. Standard finish is chrome

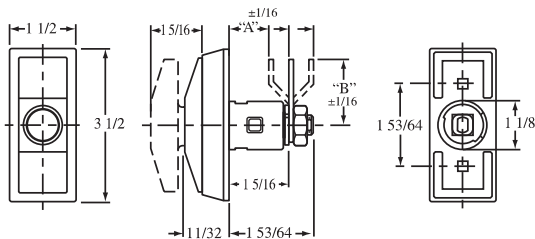

Part No.
CHL OU 4200 NA

"T" Handle For limited spaces

Note: handle and cylinder dimensions do not conform to NAMA dimensional standards.

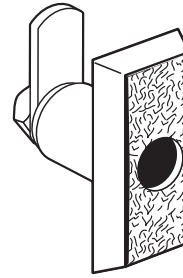

- Accepts Ace II cylinder 4260-19
- Standard finish is chrome
- Customer must furnish "A" and "B" dimensions

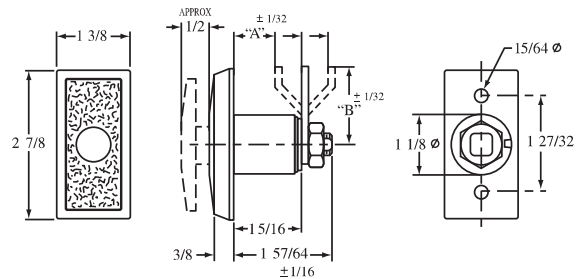

Part No.
CHL 4260 KA 7559
CHL 4260 KD

Standard Screw Type "T" Handle

"T" Handle, 3 1/2" Stud Less Cylinder

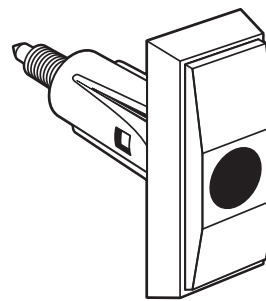

- Accepts standard and long cylinder locks which meet NAMA dimensional standards
- Textured finish for scratch resistance. Standard finish is chrome
- When fully extended, handle is free wheeling to 360°. When partially depressed, handle is free wheeling to 120°
- Furnished with 1/2" x 13 threaded stud. Stud length is 3 1/2"
- Front design has built up flange and tapered "T" handle construction

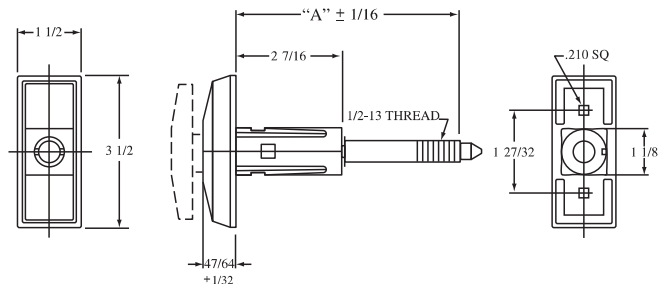

Part No.
CHL OU 4265 NA

CYLINDER LOCKS

ACE II Cylinder

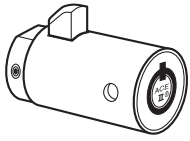

Features

- Ace II patented assembly
- 7 Pin tumbler
- Brass locking bolt
- Set screw hole for anti-pull feature*
- Standard finish: chrome
- Thousands of combinations available
- Furnished with 2 keys each
- Meets NAMA dimensional standards
- Available keyed alike, keyed different
- Fits OU 4200 and OU 4265

* When used in "T" Handle with set screw feature

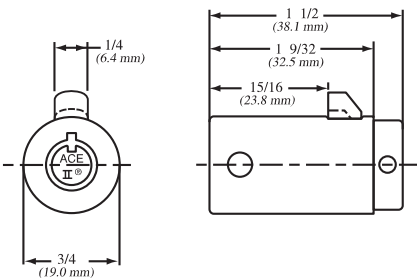

Part No.
CHL 4255-19RL KA SP802
CHL 4255-19RL KD

ACE II Inner Cylinder



Features

- Ace II patented assembly
- For use in OU-4260 T Handle only
- 7 pin tumbler
- Brass locking pin
- Standard finish: chrome
- Thousands of key combinations available
- Furnished with two keys each
- Available keyed alike, keyed different

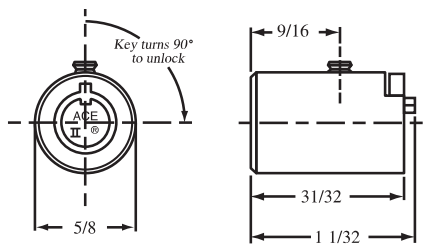

Part No.
CHL 4260-19 KA SP806
CHL 4260-19 KD

FILING CABINET LOCKS

Filing Cabinet Locks

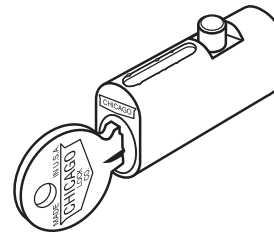

Features

- Four pin tumbler plug
- Die cast barrel with die cast bolt
- No. 5002LP has rectangular bolt
- Other models have round bolt
- Standard finish: Satin Chrome
- Two keys furnished per lock

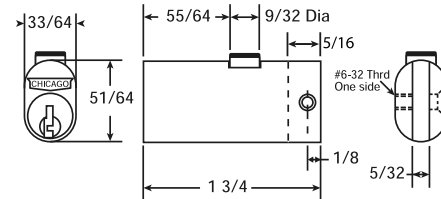

CHL 5001LP

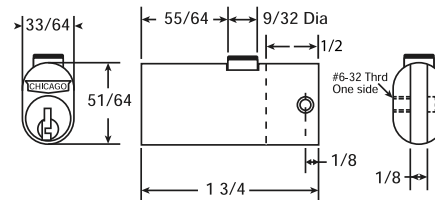

CHL 5001 50LP

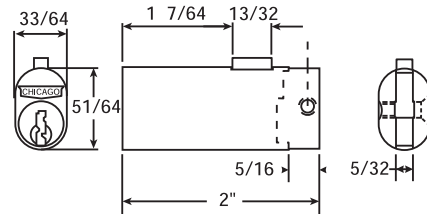

CHL 5002LP

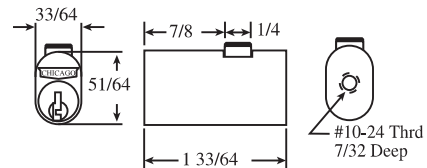

CHL EXP-19DC

Part No.
CHL 5001LP
CHL 5001 50LP
CHL EXP-19DC

STEEL CASE REPLACEMENT PLUGS

Plug Assembly



- Retrofits in seconds with the use of the removal tool
- 6 disc tumbler construction easily rekeyable with 99094-000 Service Kit
- Set up your own code systems for each customer with the CP-1076-90 Sub-assembled plug and 99094-000 Service lot

Part No.
CHL P1076 KA 100R
CHL P1076 KD

Removal Tool:

Part No.
CHL K100 RK68

ACCESSORIES

Protecting Collar

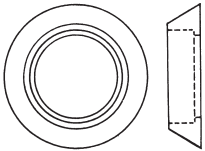

This hardened washer protects the exposed shoulder of the lock from twisting with a wrench or special tools.

1 3/8" diameter, 5/16" thickness

Part No.
CHL 4032 13

Steel Washer

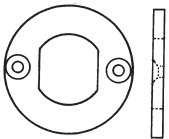

1 5/16" outside dia. by 1/8" thick. Hole to fit 3/4" lock barrel with two flats. .625" across. Washer fastened to wood with two 1/2" wood screws.

Part No.
CHL 2059-25

Hex Nut

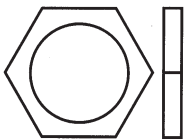

For cam lock body

Part No.
CHL 2371

KEY BLANKS

Genuine Chicago Lock key blanks are packed 50 per box.



K-4-L
Off Center Left



K-4
Center Groove



K-4-R
Off Center Right



K-2-W
"W" Milling



K-4-W
"W" Milling



K-2
Center Groove

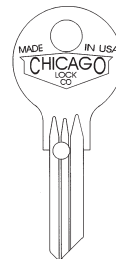

K-100-MH
6-Tumbler

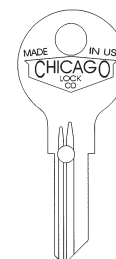

K-102-H
6-Tumbler

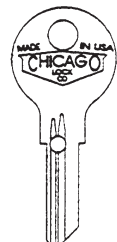

K-103-H
Tumbler

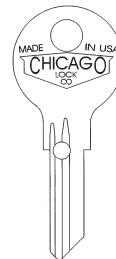

K-104-H
6-Tumbler

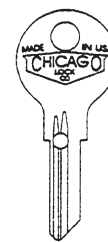

K-101-H
6-Tumbler



K-5
5-Tumbler

KEY BLANKS

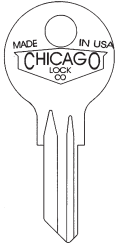

 K-9
5-Tumbler

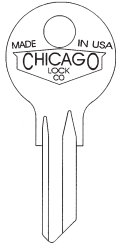

 K-35
5-Tumbler



 K-35-M
5-Tumbler



 K-38
5-Tumbler



 K-39
5-Tumbler



 K-P-1
4-Pin Tumbler



 K-P-2
4-Pin Tumbler



 K-P-3
4-Pin Tumbler



 K-P-4
4-Pin Tumbler

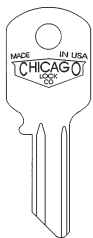

 K-P-9
4-Pin Tumbler

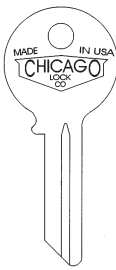

 K-P-12
5-Pin Tumbler



137CLC
ACE® & ACE II®
Keyblank