

TIMBERLINE LOCK, LTD.

Locks for wood furniture and cabinets...

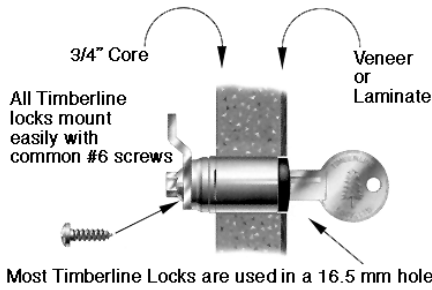

- Wide selection of locks to fit most furniture and cabinet applications
- Available in several high quality finishes
- Removable lock plugs for complete keying versatility

Lock Plugs



Features:

- Small Diameter
- High Quality/Long Life
- Solid Brass Keys
- Coded on Face & Keys
- Master-Keyed Standard
- Removable Lock Plug

Part No.	Description
TBL C100LP 14A KA	Nickel Plug KA
TBL C100LP 14A KD	Nickel Plug KD
TBL C200LP 8 KA	Old English Plug KA
TBL C200LP 8 KD	Old English Plug KD
TBL C300LP 19 KA	Black Plug KA
TBL C300LP 19 KD	Black Plug KD
TBL C400LP 20 KA	Bronze Plug KA
TBL C400LP 20 KD	Bronze Plug KD
TBL C500LP 3 KA	Brass Plug KA
TBL C500LP 3 KD	Brass Plug KD

Bezels



Allows cylinder bodies to be used with 3/4" through 7/8" diameter holes and permits use of locks in 7/8" thick panels.

Part No.	Description
TBL C100 BZ 14A	Nickel Bezel
TBL C200 BZ 8	Old English Bezel
TBL C300 BZ 19	Black Bezel
TBL C400 BZ 20	Statuary Bronze Bezel
TBL C500 BZ 3	Brass Bezel

Change Tool



Required to install and remove lock plugs in cylinder bodies.

Part No	Description
TBL D500KY	Key, control Plug Install/Removal

Thick Panel Lock

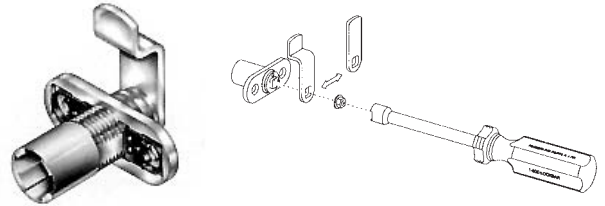

Universal type lock for either doors or drawers that can accommodate panel thickness from 7/8" to 1 3/8" thick. 90° cam rotation, CCW to lock.

- Keying – Order lock plug separately
- Housing supplied with straight cam and bent cam. Housings are unplated.

Part No	Description
TBL C170CB	Drawer Lock, thick panel, less cylinder

R LOCKS

Surface Mounted Door Lock



Surface mounted lock for locking doors. Setback of 9/32" is ideal for overlay doors. 180° key rotation, CCW to lock, key removable in both locked and unlocked positions.

- Keying – Order lock plug separately
- Housing is black, toughened nylon. Cylinder is unplated. Cams are zinc plated.

Part No	Description
TBL C290CB	Door Lock, vertical mount less cylinder

Low-Profile Surface Mounted Door Lock



Low profile, surface mounted lock for locking doors. Setback of 3/32" is ideal for inset doors or locking one door behind another.

- 180° key rotation, CCW to lock, key removable in both locked and unlocked positions.
- Keying – Order lock plug separately
- Housing is black, toughened nylon. Cylinder is unplated. Cams are zinc plated.

Part No	Description
TBL C240CB	Door Lock, vertical mount less cylinder

Double Door Lock

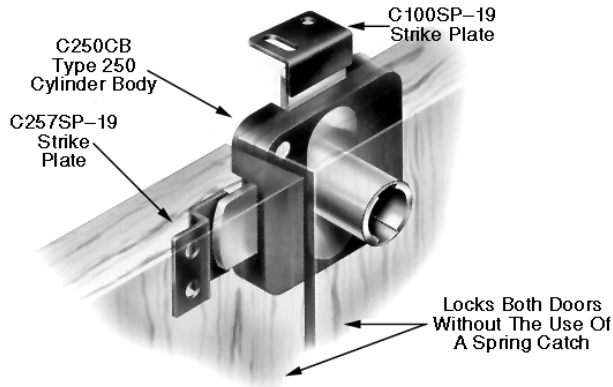

Surface mounted lock for locking two adjacent doors. Eliminates the need for a spring catch on the door opposite the lock. Works with either overlay or inset doors.

- 180° cam rotation, CCW to lock, key removable in both lock and unlocked positions
- Keying – Order lock plug separately
- Supplied with two strike plates as shown. Housing is black, toughened nylon. Cylinder is unplated. Cams are zinc plated.

Part No **Description**
TBL C250CB-----Door Lock, double door Less cylinder

Push Lock

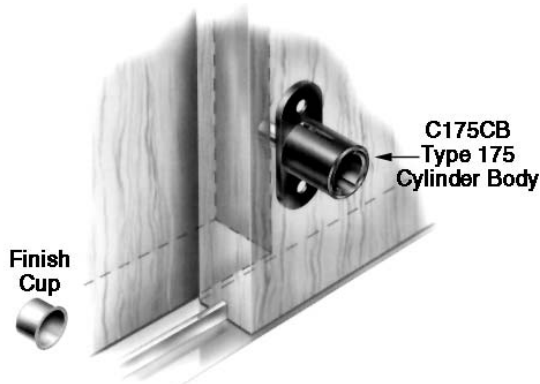

For locking sliding, bypass type doors. Requires 3/4" hole in front door for cylinder.

- Pushing in cylinder locks doors, with or without key. 45° key rotation allows cylinder to pop back out to unlock doors. Key removable in both locked and unlocked positions.
- Keying – Order lock plug separately
- Supplied with nickel plated finish cup. Housing is black, toughened nylon.

Part No **Description**
TBL C175CB-----Push Lock, sliding door, less cylinder

DRAWER LOCKS

Drawer Lock



Surface mounted lock for locking drawers. Setback of 9/32" is ideal for overlay drawers.

- 180° key rotation, CCW to lock, key removable in both locked and unlocked positions.
- Keying – Order lock plug separately.
- Cylinder is black, toughened nylon. Cylinder is unplated. Cams are zinc plated.

Part No **Description**
TBL C280CB-----Drawer Lock, horizontal mount, less cylinder

Low Profile Drawer Lock



Low profile, surface mounted lock for locking drawers. Setback of 3/32" is ideal for inset drawers

- 180° key rotation, CCW to lock, key removable in both locked and unlocked positions.
- Keying – Order lock plug separately
- Cylinder is black, toughened nylon. Cylinder is unplated. Cams are zinc plated.

Part No **Description**
TBL C230CB-----Drawer Lock, horizontal mount, less cylinder

Two Drawer Side Gang Lock

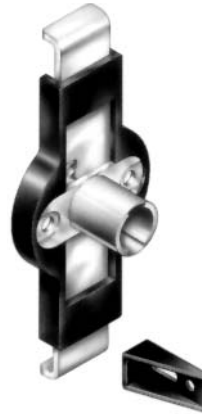

Two drawer gang lock for locking two pedestal drawers with a single lock. Lock mounts on side of cabinet

- 180° key rotation, CCW to lock, key removable in both locked and unlocked positions.
- Keying – Order lock plug separately
- Housing supplied with two C500DC – 19 Drawer Clips. Cams are zinc plated.

Part No **Description**
TBL D270CB ---Gang Lock, 2 drawer, less cyl

Front Gang Lock

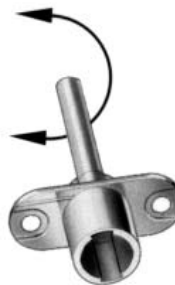

For locking banks of drawers in desks, credenzas and other multiple drawer applications. Lock mounts on front of cabinet.

- 180° key rotation, CCW to lock, key removable in both locked and unlocked positions.
- Keying – Order lock plug separately
- Cylinder is unplated

Part No **Description**
TBL D100CB -----Gang Lock, front mount, less cylinder

Side Gang Lock



For locking banks of drawers in desks, credenzas and other multiple drawer applications. Lock mounts on side of cabinet.

- 180° key rotation, CCW to lock, key removable in both locked and unlocked positions.
- Keying – Order lock plug separately
- Cylinder is unplated

Part No. TBL D150CB ----- **Description** Gang Lock, side mount, less cylinder

Cam Lock Kit



Universal type lock for either doors or drawers. Kit contains a variety of easily switched cams to accommodate most locking situations.

- 90° cam rotation, CCW to lock
 - Keying – Order lock plug separately
 - Cylinder supplied with two straight cams and two bent cams.
- Cylinder is unplated. Cams are zinc plated.

Part No. TBL C165CB --- **Description** Cam Lock, universal W/4 cams less cylinder

ACCESSORIES

Strikes

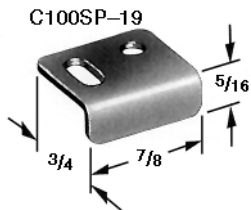

Part No. TBL C100SP-19 ----- **Description** Black Strike, type 100

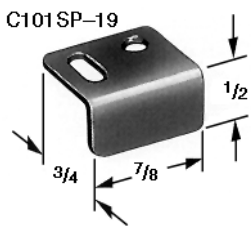

Part No. TBL C101SP-19 ----- **Description** Black Strike, type 101

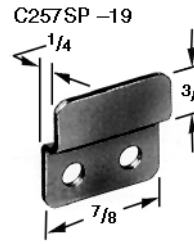

Part No. TBL C257SP-19 ----- **Description** Black Strike, type 257

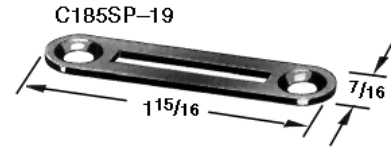

Part No. TBL C185SP-19 ----- **Description** Black Strike, type 185

Drawer Clip

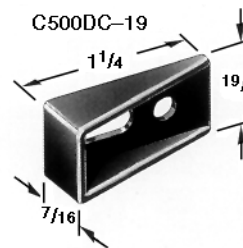

Part No. TBL C500DC-19 ----- **Description** Black Drawer Clip

Key Blank



Part No. TBL D300KY ----- **Description** Timberline Key

Drill Bit



Part No. TBL C165DB ----- **Description** Tool, Drill Bit 16.5MM