

KEY MACHINES

Semi-Automatic Key Duplicating Machines

Designed and manufactured in the U. S. A.

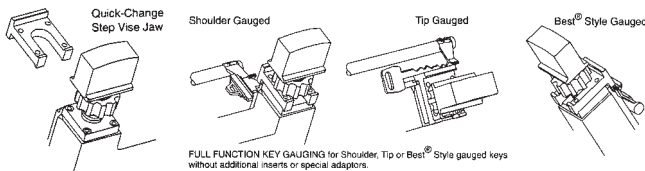
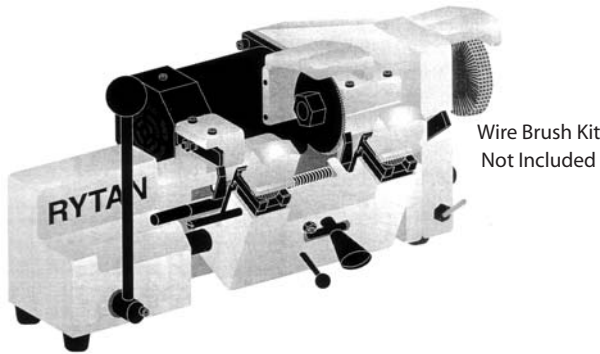

- Fast & Accurate:** High speed “stick-shift” key cutting action works faster, smoother and more accurately than any other machine you can buy.
- Premium Quality:** Precision machined parts made in Ryтан’s state-of-the-art factory assure you of a top quality machine and accurate, precise key duplicating.
- Advanced Features:** Unique full-function key gauging, built-in cutter shaft lock, large diameter key cutter, quick change step vise jaws, heavy-duty ball bearing motor, and wide spaced vise jaws to hold large headed keys.
- Built to Last:** The Ryтан RY100’s rugged heavy-duty construction is built to take the most demanding use in the toughest work environments. Rigid backbone main housing, 3/4" diameter carriage shaft, and powerful motor make this machine the choice of high volume shop owners.
- Shop or Van Use:** Order the RY100DC with a powerful 12 volt D.C. motor with no sacrifice in power.
- Factory Support:** When you call the Ryтан factory you are talking to technical people who make and understand the products we sell.

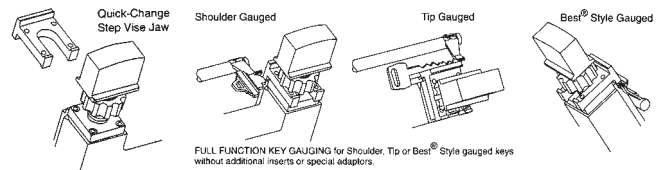
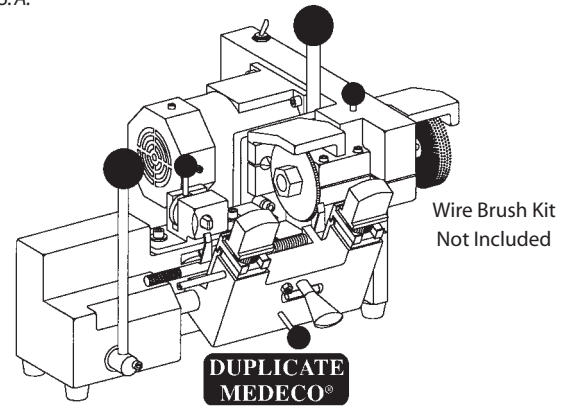

- Duplicate Medeco®:** Duplicate standard cylinder keys automotive keys and Medeco® keys on this versatile RY256 high speed semi-automatic key duplicating machine.
- Fast & Accurate:** Versatile high speed “stick-shift” key cutting action cuts keys smooth and accurately – and you can cut Medeco® without changing the machine.
- Premium Quality:** Precision machined parts made in Ryтан’s state-of-the-art factory assure you of a top quality machine and accurate, precise key duplicating.
- Advanced Features:** Unique full-function key gauging, built-in cutter shaft lock, large diameter key cutter, quick change step vise jaws, heavy-duty ball bearing motor, and wide spaced vise jaws to hold large headed keys.
- Built to Last:** The RY256’s rugged heavy-duty construction is built to take the most demanding use in the toughest work environments. Rigid back-bone main housing, 3/4" diameter carriage shaft, and powerful motor make this machine the choice of high volume shop owners.
- Shop or Van Use:** Order the RY256DC with a powerful 12 volt D.C. motor with no sacrifice in power.
- Factory Support:** When you call the Ryтан factory you are talking to technical people who make and understand the products we sell.

Part No.	Description
RTN RY-100 -----	Semi-Automatic Key Machine
RTN RY-100-DC -----	Semi-Automatic Key Machine w/ 12 V Motor

Part No.	Description
RTN RY-256 -----	RAMM Key Machine

KEY MACHINE PARTS & ACCESSORIES

Wire Brush Kit

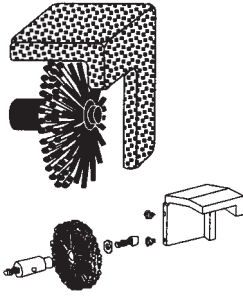

Wire brush kit provides gentle deburring action with minimum wear on cut keys. Soft abrasive impregnated Nylon bristles reduces key grabbing and are less harmful to your fingers than metal wire brushes. *Fits the following Rytan machines:*

- RY100 High Speed Key Duplicator
- RY256 High Speed Key Duplicator & Medeco®
- RY45 Manual Key Duplicator

Part No.
RTN RY-100-101

Replacement Wire Brush



This soft Nylon wire brush is the safest wire brush you can use on your Rytan key machine. The soft bristles help prevent pulling the key into the brush while deburring the key. Helps prevent injury due to flying bristles sometimes encountered when using a metal-bristle wire brush. Use with Wire Brush Kit RY101. *Fits the following Rytan machines (with RY101 wire brush kit installed):*

- RY100 High Speed Key Duplicator
- RY256 High Speed Key Duplicator & Medeco®
- RY45 Manual Key Duplicator

Part No.
RTN RY-9074

Replacement Cutter



Standard key duplicating machine cutter, used to cut standard cylinder keys and Medeco®. Made from the highest quality premium tool steel money can buy and precision ground to the most exacting specifications. *Fits the Following Rytan Machines:*

- RY100 High Speed Key Duplicator
- RY256 High Speed Key Duplicator & Medeco®
- RY45 Manual Key Duplicator

Part No.: RTN RY-100-030

Auxiliary Lamp Kit

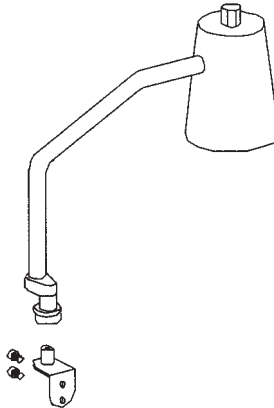

High quality lamp kit is a must for shops with inadequate lighting where your key machine is located. Good lighting not only improves your workmanship but improves safety when operating motorized equipment. Use 40 watt, 115 volt A.C. bulb (not included). Lamp is fully adjustable with it's own on/off switch and power cord.

Fits the following Rytan machines:

- RY100 High Speed Key Duplicator
- RY256 High Speed Key Duplicator & Medeco®

Part No.
RTN RY-39

Left Hand Key Gauge



This key gauge can get damaged when you don't flip down the key gauges all the way and you force it into the stylus holder when you operate the stick shift to begin cutting a key. Doesn't hurt the machine but does knock your spacing out of adjustment. Fits RY100s and RY256s.

Part No.
RTN RY10050

Right Hand Key Gauge



This is the most popular replacement key gauge because it often gets cut when someone forgets to flip down the key gauges before cutting a key. Made from mild steel, it won't damage your key machine cutter.

Part No.
RTN RY10048

Drive Linkage Shoulder Screw



Replacement broken drive linkage shoulder screw. You can reduce the chance of screw breakage in your service van if you release your carriage against a piece of heavy cardboard placed between the carriage vises and the machine's cutter and stylus when you drive.

Part No.
RTN RY9059

Ball Bearing Spindle Assembly

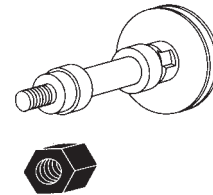

This precision spindle assembly is made from a solid billet of steel, heat treated and precision ground, and spinning on two wide space, oversized sealed ball bearings For model RY100.

Part No.
RTN RY-84

Carriage Spring



Replace weak or broken key carriage spring only, if pins are not lost or worn.

Part No.
RTN RY100-25

Carriage Spring Assembly

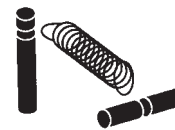

Replace weak or broken key carriage spring and lost or worn pins as an assembly to restore semi-automatic stick-shift speed and versatility.

Part No.
RTN RY-85

Quick-Change Standard Stylus

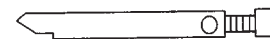

Replacement quick-change standard stylus. Has built-in depth adjustment. Use with your standard RY10030 cylinder key cutter and RY111 slotter kit.

Part No.
RTN RY-100-118

KEY MACHINE PARTS & ACCESSORIES

Replacement Drive Belts

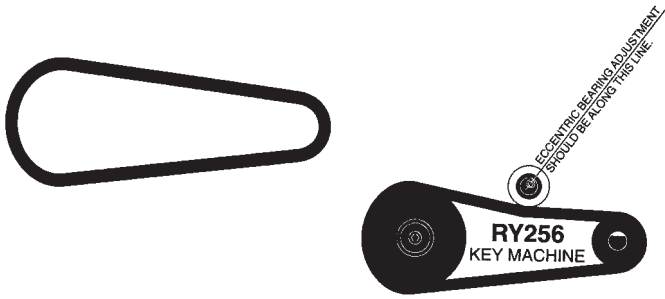

This is an exact replacement for the fiber reinforced 60° V-belt that came with your machine. When installing a belt on the RY45 always loosen the motor screws, then slip on the belt and tighten the belt tension with the motor and tighten the motor screws. On the RY256 loosen the idler bearing (see picture above), then slip on the belt and tighten the idler bearing screw.

Fits the Following Rytran Machines:

- RY45 Manual Key Duplicator
- RY256 High Speed Key Duplicator and Medeco®

Part No.
RTN RY-9085



This is an exact replacement for the fiber reinforced 60° V-belt that came with your machine. When installing the belt, always loosen the motor screws and then slip on the belt — then tighten the belt tension with the motor and tighten the motor screws.

Fits the RY100 High Speed Key Duplicator

Part No.
RTN RY-9039

Note: Do Not Force the Belt Over the Pulleys.

Quick-Change Reversible Top Vise Jaw

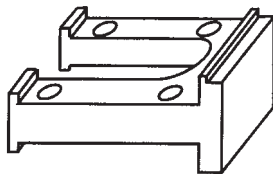

Precision machined from mild steel PM castings, the top vise jaw is critical to maintaining your key machine's accuracy. Periodically inspect the top vise jaw for signs of wear or mushrooming of the clamping surfaces which can occur if you cut allot of double sided steel foreign automotive keys. Fits RY100 and RY256 key machines.

Part No.
RTN RY-89

TOOLS

Plug Spinner

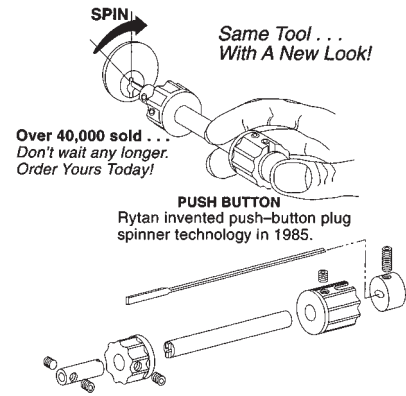

Sometimes a lock will resist picking open but will pick in the opposite direction. In cases like this the best solution is to spin the plug back past the shear line and over to the open position.

You need lots of speed to spin the cylinder plug past the shear line without causing the lock to relock. The Rytran RY57 Plug Spinner will do the job for you time and time again — all with the simple push of a button.

Part No.
RTN RY-57

Part No.	Description
RTN RY57RB	-----Replacement Blades

Code Punch Machine

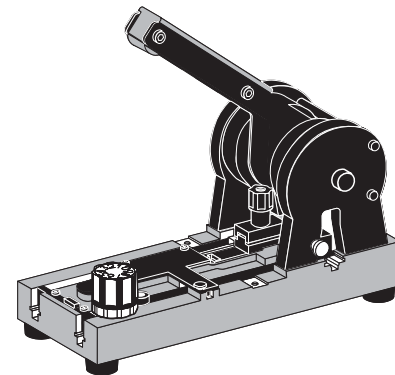

The Rytran code punch machine can punch keys for nine different keyways, including Arrow, Corbin, Dexter, I-Core, Kwikset, Schlage (Classic and Everest), Schlage (Reverse), Weiser and Weslock. In certain configurations, such as Schlage classic and Kwikset, the RY2000 can be set up to cut both at the same time. Just like having two machines at your fingertips. Heavy duty all steel punch mechanism for extreme key punching of large production orders. Large key clamp knob with built in thrust bearing. Keyway interchange as well as depth and space adjustment can all be done in the field.

Part No.
RTN RY2000SCH
Conversion parts for Rytran RY2000 to convert to Kwikset Keyway:

Part No.	Description
RTN RY2026LH	-----Kwikset Depth Driver
RTN RY4079SB	-----Kwikset Space Bar
RTN RY5079DS	-----Kwikset Depth Selector Assembly
RTN RY6079PD	-----Kwikset Punch & Die Assembly

TOOLS

Kwikset Cylinder Tool

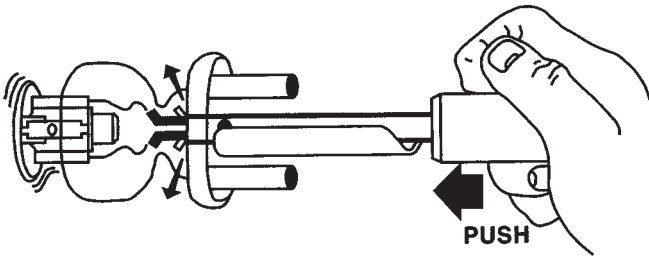

This tool pops the cylinders out of popular “400” series knob locks in a jiffy! The self-aligning design insures that the expanding tips come in direct contact with the locks retainer clips every time. Simply insert the tool and push the spring loaded handle – out pops the cylinder!

This high-speed tool is ideal for rekeying those large Kwikset installations. The ease at which this tool performs its job is reason enough to own one... Whether you are a large high-volume shop or an individual who likes quality tools, you will appreciate the RY36.

Part No.
RTN RY-36

Roto-Puller Universal Steering Wheel Puller

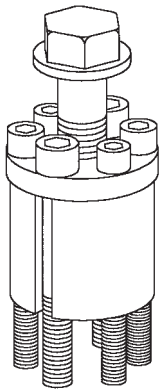

Universal steering wheel puller for Dodge, GM, Ford, AMC. Telescopic and non-telescopic models. Rotating tipped pusher makes removing steering wheel from shaft much easier. Three sizes of threaded bolts installed in the tool insures you will always have the right size handy when you're on the job.

Part No.
RTN RY-23

Glove Compartment Plug Removal Tool

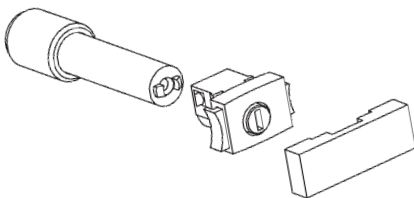

Engineered to do the job right! Our exclusive automatic plunger action is the only proven method to remove plug from lock body. Simply spread the lock's two plastic retainers, insert the tool and push on the power plunger. The plug is automatically released from the body.

Part No.
RTN RY-17

LOCK PICK INSTRUMENT SETS

Each instrument is made of the finest clock spring or stainless steel — hardened and finished to exacting standards. Rytan instruments with form-fitting ergonomic handles are made of two components permanently fused together for assured long life. All instrument cases are made of the finest materials, carefully stitched for increased durability.

9 Instrument Lock Pick Set

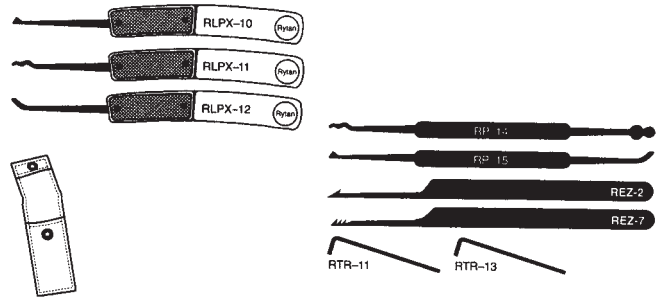

Rytan's most economical pick set. Includes nine popular instruments. This down-sized set is ideal for the beginner, as it contains traditional rake, hook and diamond style picks, PLUS basic tension wrenches, broken key extractors and double-ended combination instruments. Everything needed to practice the fundamentals and perfect your skills. Includes small pick case.

Part No.
RTN RYP-15

11 Instrument Lock Pick Set

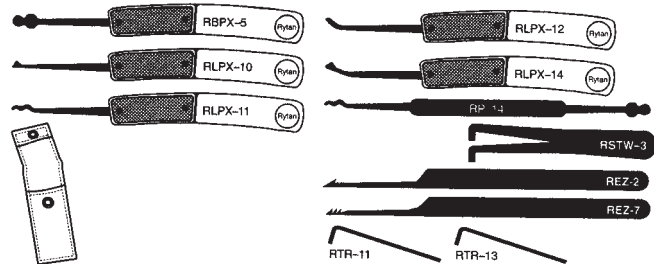

A popular set of 11 instruments. Includes an assortment of traditional size tools in popular styles with ergonomic handles PLUS broken key extractors as well as “L” and adjustable tweezer tension wrenches. Includes small pick case.

Part No.
RTN RYP-13

Items on this page are subject to restricted sales

LOCK PICK INSTRUMENT SETS

10 Instrument "Mini-Blue™" Lock Pick Set

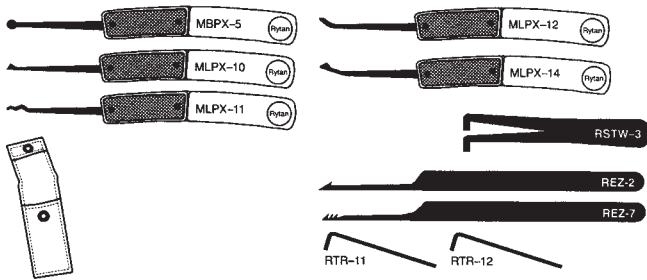

The miniature Ryтан "Mini-Blue™" lock picking instruments found in this special set are a new concept in picking tools! The pick blades are scaled down by 20% compared to traditional size picks — making them ideal for opening locks with small keyways. Great for groovings that confine the movement of regular tools. Includes small pick case.

Part No.
RTN MRPK-10

16 Instrument Lock Pick Set

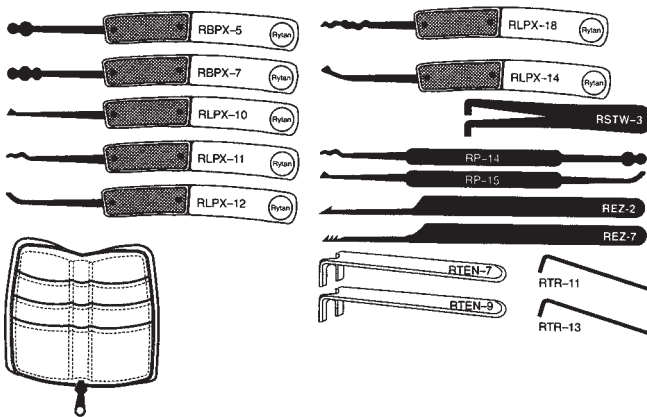

A medium size set containing 16 assorted Ryтан lock picking instruments. Included are popular traditional size ball, hook, rake and diamond styles PLUS our Tri-Ball, Diamond-Hook and Riffle designs. Double ended combination instruments for flexibility of picking methods as well as an assortment of popular tension wrenches and broken key extractors fill out this set. Includes large pick case.

Part No.
RTN RYPK

Items on this page are subject to restricted sales

32 Instrument Lock Pick Set

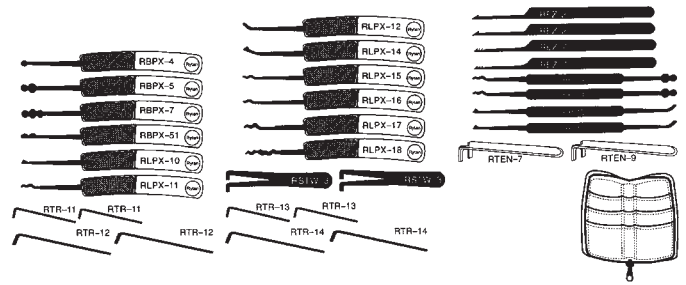

This large pick set contains all of our full size picking instruments PLUS a large selection of tension wrenches and broken key extractors. Includes a large pick case.

Part No.
RTN RYPK-32

LOCK PICK INSTRUMENTS

- Ergonomic Handles — Contoured handle design is human engineered for comfort... no other pick design fits the hand so well.
- Stainless Steel Pick Blades — Our new stress-free processing and improved hardening technique produces the toughest pick blades in the business!
- Traditional Style Picks — We have twelve traditional pick styles... one-third are special styles.
- Miniature Style Picks — We have five miniature pick styles... use these unique picks for smaller keyways... they're 20% smaller tips.
- Broken Key Extractors — Our single and triple barb extractors are made from the same tough stainless steel used on our pick blades!
- Tension Wrenches — Our RTR style tension wrenches are also made from the same tough stainless steel used on our pick blades!

Ergonomic Picks

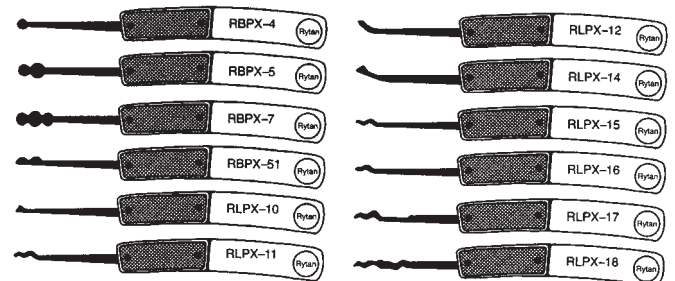

- Stainless Steel Blades

Part No.	Description
RTN RBPX-4	F/Sgl Lg Ball Pick
RTN RBPX-5	Full Dbl Pick
RTN RBPX-51	1/2 Dbl Ball Pick
RTN RBPX-7	F/Triple Ball Pick
RTN RLPX-10	Std Diamond Pick
RTN RLPX-11	Std Full Rake Pick
RTN RLPX-12	Standard Hook Pick
RTN RLPX-14	Diamond Angled Hook Pick
RTN RLPX-15	Std 3/4 Rake Pick
RTN RLPX-16	Std 1/2 Rake Pick
RTN RLPX-17	Mod Full Rake Pick
RTN RLPX-18	Riffle Rake Pick

LOCK PICK INSTRUMENTS

Broken Key Extractors

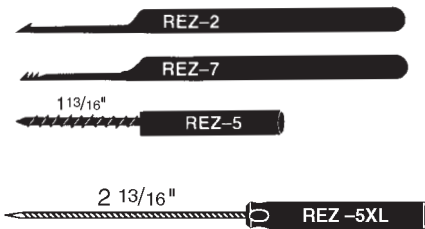

- Stainless Steel Blades
- Hardened spiral blades are mechanically crimped onto machined aluminum handles to create the best spiral key extractors available.

Part No.
 RTN REZ-2
 RTN REZ-5
 RTN REZ-5XL
 RTN REZ-7

"Mini-Blue™" Picks

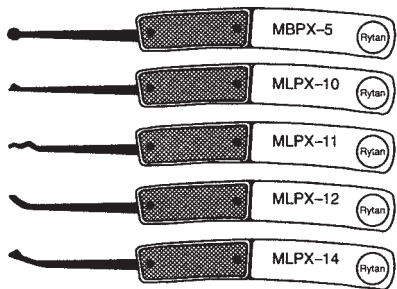

Part No.	Description
RTN MBPX-5	Double Ball Pick
RTN MLPX-10	Mini Diamond Pick
RTN MLPX-11	Mini Std Full Rake
RTN MLPX-12	Mini Hook Pick
RTN MLPX-14	Mini-Angled Hook

TENSION WRENCHES

Adjustable Tweezer



Part No.
 RTN RSTW-3

"U" Shape Tension Wrenches



Part No.	Description
RTN RTEN-7	Narrow Tension Wrench
RTN RTEN-9	Wide Tension Wrench

"L" Shape Tension Wrenches



Part No.	Description
RTN RTR-11	Sh/Li Tension Wrench
RTN RTR-12	Lg/Li Tension Wrench
RTN RTR-13	Sh/Med Tension Wrench
RTN RTR-14	Lg/Med Tension Wrench

Items on this page are subject to restricted sales